

Projection Television

55P916

60P916

64P916

Instructions for use



Let's make things better.



PHILIPS

Return your Warranty Registration card today to ensure you receive all the benefits you're entitled to.

Once your PHILIPS purchase is registered, you're eligible to receive all the privileges of owning a PHILIPS product. So complete and return the Warranty Registration Card enclosed with your purchase at once. And take advantage of these important benefits.

Warranty Verification

Registering your product within 10 days confirms your right to maximum protection under the terms and conditions of your PHILIPS warranty.

Owner Confirmation

Your completed Warranty Registration Card serves as verification of ownership in the event of product theft or loss.

Model Registration

Returning your Warranty Registration Card right away guarantees you'll receive all the information and special offers which you qualify for as the owner of your model.

Congratulations on your purchase, and welcome to the "family!"



PHILIPS



Dear PHILIPS product owner:

Thank you for your confidence in PHILIPS. You've selected one of the best-built, best-backed products available today. And we'll do everything in our power to keep you happy with your purchase for many years to come.

As a member of the PHILIPS "family," you're entitled to protection by one of the most comprehensive warranties and outstanding service networks in the industry.

What's more, your purchase guarantees you'll receive all the information and special offers for which you qualify, plus easy access to accessories from our convenient home shopping network.

And most importantly you can count on our uncompromising commitment to your total satisfaction.

All of this is our way of saying welcome—and thanks for investing in a PHILIPS product.

Sincerely,

Robert Minkhorst
President and Chief Executive Officer

P.S. Remember, to get the most from your PHILIPS product, you must return your Warranty Registration Card within 10 days. So please mail it to us right now!

Know these safety symbols



This "bolt of lightning" indicates uninsulated material within your unit which may cause an electrical shock. For the safety of everyone in your household, please do not remove product covering.

The "exclamation point" calls attention to features for which you should read the enclosed literature closely to prevent operating and maintenance problems.

WARNING: TO PREVENT FIRE OR SHOCK HAZARD, DO NOT EXPOSE THIS EQUIPMENT TO RAIN OR MOISTURE.

CAUTION: To prevent electric shock, match wide blade of plug to wide slot, and fully insert.

ATTENTION: Pour éviter les chocs électriques, introduire la lame la plus large de la fiche dans la borne correspondante de la prise et pousser jusqu'au fond.

Let's make things better.

INTERNET ADDRESS: <http://www.philipsusa.com>

SAFETY INSTRUCTIONS - Read before operating equipment

This product was designed and manufactured to meet strict quality and safety standards. There are, however, some installation and operation precautions which you should be particularly aware of.

1. **Read Instructions** - All the safety and operating instructions should be read before the appliance is operated.
2. **Retain Instructions** - The safety and operating instructions should be retained for future reference.
3. **Heed Warnings** - All warnings on the appliance and in the operating instructions should be adhered to.
4. **Follow Instructions** - All operating and use instructions should be followed.
5. **Water and Moisture** - The appliance should not be used near water - for example, near a bathtub, washbowl, kitchen sink, laundry tub, in a wet basement or near a swimming pool, etc.
6. **Carts and Stands** - The appliance should be used only with a cart or stand that is recommended by the manufacturer.
- 6A.  An appliance and cart combination should be moved with care. Quick stops, excessive force, and uneven surfaces may cause the appliance and cart combination to overturn.
- 6B. **Tilt/Stability** - All televisions must comply with recommended international global safety standards for tilt and stability properties of its cabinet design.
 - Do not compromise these design standards by applying excessive pull force to the front, or top, of the cabinet which could ultimately overturn the product.
 - Also, do not endanger yourself, or children, by placing electronic equipment/toys on the top of the cabinet. Such items could unsuspectingly fall from the top of the set and cause product damage and/or personal injury.
7. **Wall or Ceiling Mounting** - The appliance should be mounted to a wall or ceiling only as recommended by the manufacturer.
8. **Ventilation** - The appliance should be situated so that its location or position does not interfere with its proper ventilation. For example, the appliance should not be situated on a bed, sofa, rug, or similar surface that may block the ventilation openings; or, placed in a built-in installation, such as a bookcase or cabinet that may impede the flow of air through the ventilation openings.
9. **Heat** - The appliance should be situated away from heat sources such as radiators, heat registers, stoves, or other appliances (including amplifiers) that produce heat.
10. **Power Sources** - The appliance should be connected to a power supply only of the type described in the operating instructions or as marked on the appliance.

11. **Power-Cord Protection** - Power supply cords should be routed so that they are not likely to be walked on or pinched by items placed upon or against them, paying particular attention to cords and plugs, convenience receptacles, and the point where they exit from the appliance.
12. **Cleaning** - The appliance should be cleaned only as recommended by the manufacturer.
13. **Power Lines** - An outdoor antenna should be located away from power lines.
14. **Outdoor Antenna Grounding** - If an outside antenna is connected to the receiver, be sure the antenna system is grounded so as to provide some protection against voltage surges and built up static charges.

Section 810 of the National Electric Code, ANSI/NFPA No. 70-1984, provides information with respect to proper grounding of the mats and supporting structure grounding of the lead-in wire to an antenna discharge unit, size of grounding connectors, location of antenna-discharge unit, connection to grounding electrodes and requirements for the grounding electrode. See Fig. below.
15. **Non-use Periods** - The power cord of the appliance should be unplugged from the outlet when left unused for a long period of time.
16. **Object and Liquid Entry** - Care should be taken so that objects do not fall and liquids are not spilled into the enclosure through openings.
17. **Damage Requiring Service** - The appliance should be serviced by qualified service personnel when:
 - A. The power supply cord or the plug has been damaged; or
 - B. Objects have fallen, or liquid has been spilled into the appliance; or
 - C. The appliance has been exposed to rain; or
 - D. The appliance does not appear to operate normally or exhibits a marked change in performance; or
 - E. The appliance has been dropped, or the enclosure damaged.
18. **Servicing** - The user should not attempt to service the appliance beyond that described in the operating instructions. All other servicing should be referred to qualified service personnel.

Note to the CATV system installer: This reminder is provided to call the CATV system installer's attention to Article 820-40 of the NEC that provides guidelines for proper grounding and, in particular, specifies that the cable ground shall be connected to the grounding system of the building, as close to the point of cable entry as practical.

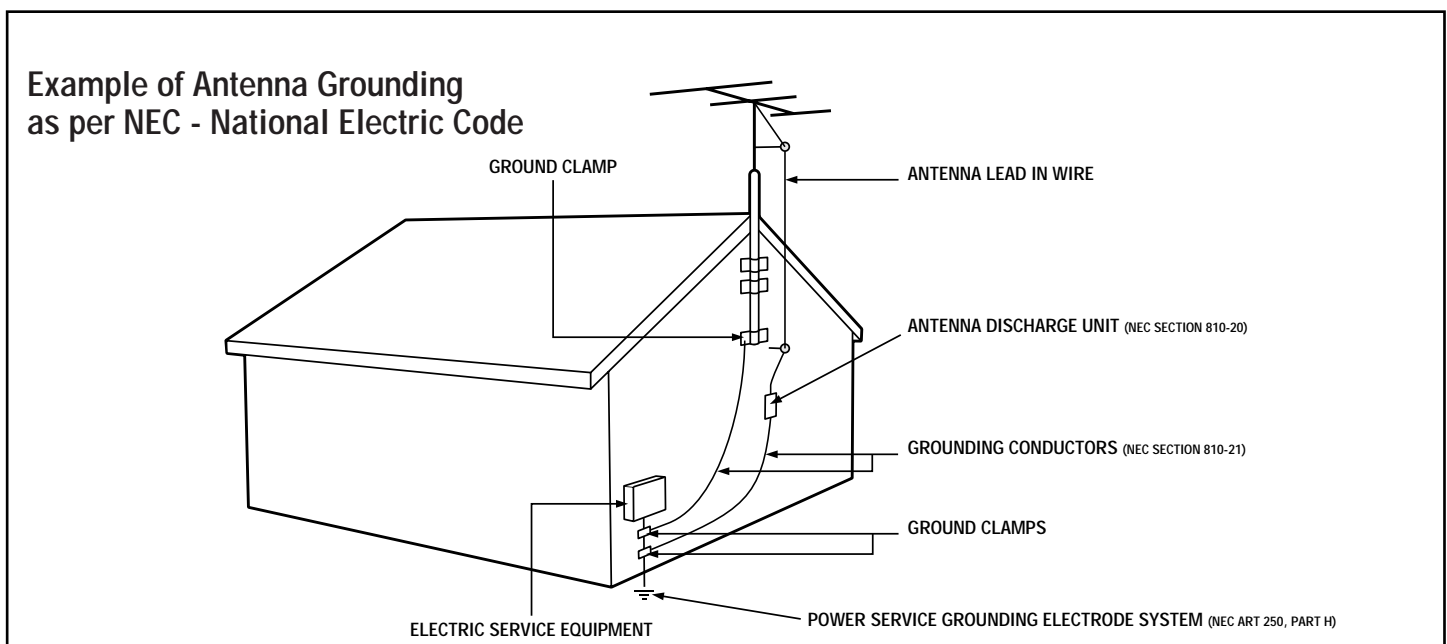

TABLE OF CONTENTS



Getting Started

Welcome/Product Registration	2
Safety/Precautions	3
Table of Contents	4
Features, Model and Cabinet Information	5



On-Screen Features

PICTURE MENU

◇ Adjusting Color, Brightness, Sharpness, Tint, and Picture Controls	6
◇ Using the Clearview Control	7
◇ Adjusting the TV's Convergence Control	8
◇ Using the Flesh Correction Control	9

FEATURES MENU

◇ Selecting a Picture Source	10
◇ Setting the TV for Closed Captioning	11
◇ Setting the TV for Cable or Antenna Signals	12
◇ Adding Channels in Memory (Automatically)	13
◇ Adding Channels in Memory (Manually)	14
◇ Setting the TV Clock	15
◇ Alarm Timer	16
◇ Using the Sleep Timer Control	17
◇ Adjusting the Channel Display Control	18
◇ Using the Time/Channel Reminder Control	18
◇ Using Parental Control/Content Advisory:	
• Code Setup/Blocking Channels	19-20
• Content Advisory - Movie Ratings	21-22
• Parental Guidelines	23
• Blocking Options/Review Settings	24
◇ Using the Channel Label Control	25
◇ Using the Language Selection Control	26

SOUND MENU

◇ Adjusting Bass, Treble, and Balance Sound Controls	27
◇ Setting the Bass Boost Control	27
◇ Setting the TV for Stereo and SAP Programs	28
◇ Using the Incredible Stereo Control	29
◇ Using the Volume Display Control	30
◇ Using the TV Speaker On/Off Control with the Audio Output jacks	31
◇ Surround Sound Speaker Connections and Variable Audio Output Control	32
◇ Using the TV's Audio/Video Input and Output Jacks	33-37



Remote Control Operation

Setting the Auto Picture Control	38-39
Using the Auto Sound Control	40
Using the Auto Surf Control	41
Setting the TV Remote to Work Optional Accessory Devices:	
Direct Entry/Code Number Method	42-43
Search and Identify Method	44
Remote Control Direct Entry Code Lists	45-46
Using the Remote's VCR buttons	47



Picture-In-Picture (PIP)

How to Use PIP (Connections)	48-49
How to Use PIP with the TV Remote	50
Selecting the Picture Source for PIP	51
Adjusting Picture-in-Picture Color and Tint	52
More PIP Connections (Cable Converter)	53



General Information

TV Help Menu	54
Tips if Something Isn't Working	55
Glossary of TV Terms	56
Index	57
Warranty	58

SET-UP AND QUICK USE GUIDE

Use the simple Set-Up Guide (supplied with your TV information packet) for details on:

- Antenna Hook-ups
- First Time Set-Up (Automatic Settings)
- Basic TV and Remote Control Operation
- On-Screen Menu Use

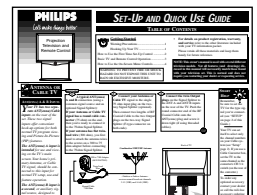

NOTE: This owner's manual is used with several different television models. Not all features (and drawings) discussed in this manual will necessarily match those found with your television set. This is normal and does not require you contacting your dealer or requesting service.

Because of continuous product improvements, the information mentioned in the documents accompanying your product are subject to change without notice.



First Time Set Up - automatically sets the TV for local channels, the correct picture signal (antenna or cable), and assists in the setting of TV's Guide Plus+ feature.

Infrared Remote Control - operates your TV set and a variety of wireless remote control VCRs, Cable TV Converters, and other accessory equipment.

Standard TV broadcast (VHF/UHF) or Cable TV (CATV) channel capability.

Closed Captioning - allows the viewer to read TV program dialogue or voice conversations as on-screen text.

Automatic Programming of channels - for quick and easy selection of favorite stations available in your area.

Picture-In-Picture (PIP) - can show a TV program and the direct video output from an accessory (VCR, etc.) onto the TV screen at the same time.

Parental Control for "Censoring" - this feature can block out channels to keep children from watching undesirable programming. Parental Guideline and Movie Rating settings can also be used as part of the new Content Advisory Data system available with TV programming.

Stereo-TV - with a built-in audio amplifier and a twin speaker system, reception of TV programs in both broadcast stereo sound or (SAP) bilingual broadcast are available.

Twin Antenna (A/B) Inputs - for easy displaying of two separate signal sources on the TV. An A/B button on the remote control switches the TV's Main screen between the two Antenna (A & B) Input options.

Audio/Video Jacks - for direct connections with VCRs (and other accessories) for quality TV picture and sound playback. Component Video Input connectors are also available for high fidelity color and picture resolution when using digital video source material, such as DVD.

Surround Sound - this TV set contains external; audio speaker connections for a more dynamic sound effect.

Sleep-Timer - automatically turns the TV OFF at preset time intervals.

Auto Button - for the control of TV Sound and the Picture levels. Use the Auto Button on the remote to quickly adjust Auto Sound (to select various audio modes matched to specific types of TV programming); Auto Picture (for programmed video level adjustments on a variety of program sources); and Auto Surf (for quick one button channel selection of up to 10 of your favorite channels).

Digital Ready - Projection Television capable of connecting to both the current analog television signals of today as well as interfacing with new upcoming digital source playback products and devices. This TV includes multiple signal connectors (Component Video, S-Video, Composite Video) which give you a variety of equipment playback options for digital set top boxes, satellite receivers, cable boxes, and other digital devices.

While there may exist some digital devices with connections not available on this television, you should be adequately prepared for the vast majority of products coming onto the digital consumer electronics' market. Note: You should always use the connection output on digital devices that gives the highest level of picture quality possible. As listed above the Component Video (or Y Pb Pr) input delivers the best color and picture reproduction; followed by S-Video; and then Composite Video. In addition to the above listed inputs, your television also includes the standard 75ohm cable signal connector for use with antennas or analog cable boxes.

As you unpack your TV please note that the following items have been included with your set:

- Owner's Manual
 - Safety Tip Information
 - Factory Service Center Locations
- Warranty Registration Card
- Remote Control Transmitter
- Batteries for Remote Control Use

Please take a few minutes to complete your registration card. The serial number for the TV is on the back of the set.

Refer to the back of this manual for instructions on the cleaning and care of the TV.

End-of-Life disposal

Your new projection television and its packaging contain materials that can be recycled and reused. Specialized companies can recycle your product to increase the amount of reusable materials and minimize the amounts which need to be properly disposed.

Your product also uses batteries which should not be thrown away when depleted, but should be handed in and disposed of as small chemical waste.

Please find out about the local regulations on how to dispose of your old television, batteries, and packaging materials whenever you replace existing equipment.

PICTURE MENU CONTROL ADJUSTMENTS

COLOR, BRIGHTNESS, SHARPNESS, TINT, PICTURE

To adjust your TV color and picture controls, select a TV channel and follow the steps shown below:

BEGIN

- 1 Select **BRIGHTNESS, PICTURE, COLOR, TINT, or SHARPNESS** picture control.

With the PICTURE MENU on screen, move the RED highlight with the outer MENU ring buttons. Then press the center MENU button to select the feature.

- 2 Press the outer MENU ring buttons to adjust the selected control.

- 3 Press the STATUS button to clear the screen.



SMART HELP



Remember. When the bar scale is centered, control settings are at normal mid-range levels.

BRIGHTNESS Press (-) or (+) until dark parts of the picture show good detail.

PICTURE Press (-) or (+) until whitest parts of the picture are as bright as you prefer.

COLOR Press (-) or (+) to add or eliminate color.

TINT Press (-) or (+) to obtain natural skin tones. (Also see Flesh Correction on page 9 for more information).

SHARPNESS Press (-) or (+) to improve detail in the picture.

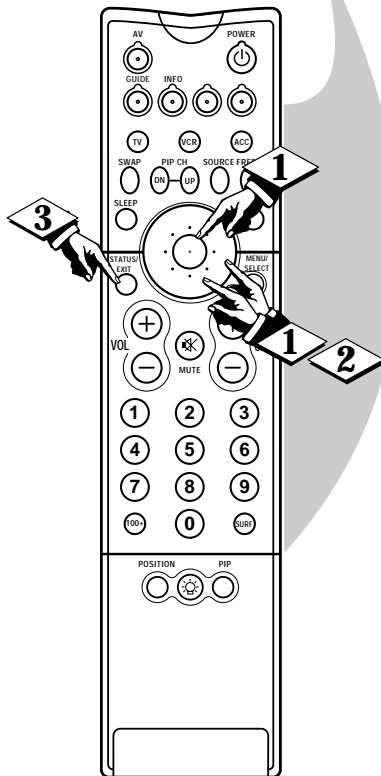
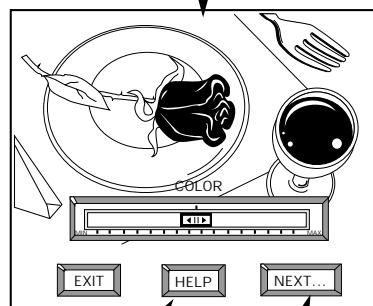
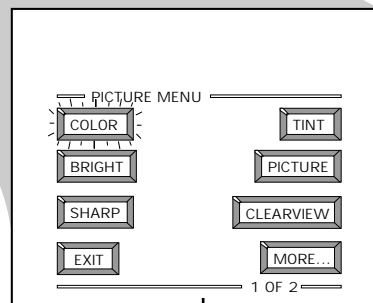
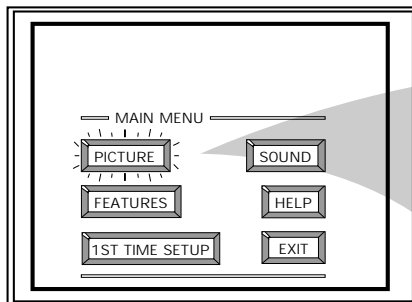

Select and then press MENU (M) button to view an explanation of the selected feature.

Select and then press MENU (M) button to view additional controls grouped under same feature heading. For Example: Tint, Brightness, Picture, etc.



CLEARVIEW

Clearview is a sharpness feature which smoothes out background snow (or picture noise) without losing picture image detail or crispness.

BEGIN

1 Select **CLEARVIEW** control.

With the PICTURE MENU on screen, move the RED highlight with the outer MENU ring buttons. Then press the center MENU button to select the feature.

2 Press the outer MENU ring buttons to move the RED highlight.

Press the center MENU button to select (✓) the ENHANCED mode.

3 Press the **STATUS** button to clear the screen.

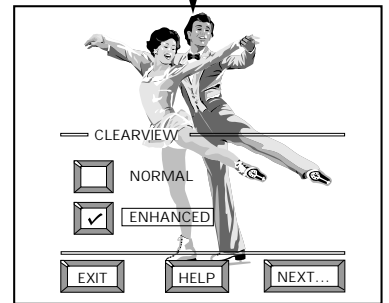
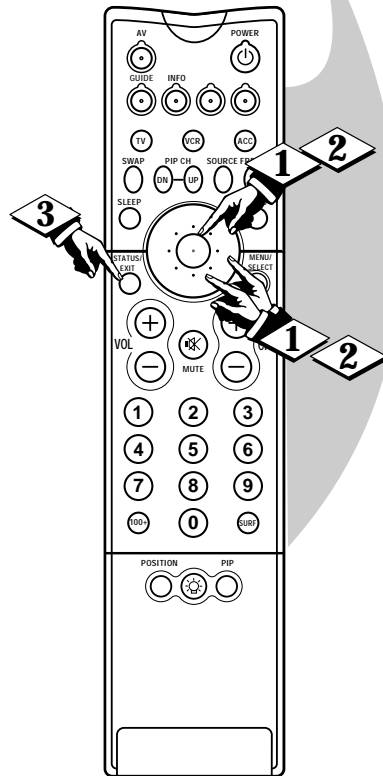
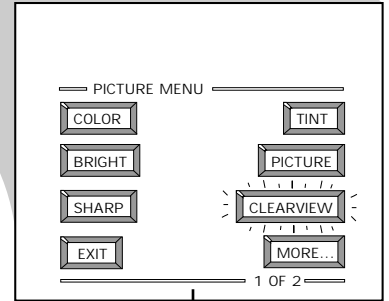
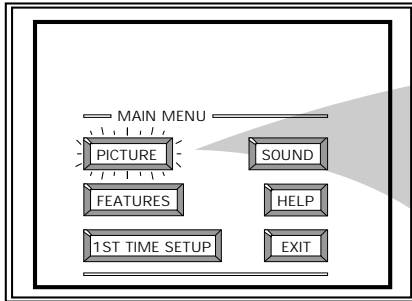

RED/BLUE CONVERGENCE

Convergence is the correct lining up of the red and blue light paths on the TV screen.

NOTE: If no color fringing (see Smart Help) shows, then no Convergence adjustments are necessary for your TV.

BEGIN

- 1 Select **CONVERGENCE** control.

With PICTURE MENU (2 of 2) on screen, move the RED highlight with the outer MENU ring buttons. Then press the center MENU button to select the feature.

- 2 If there is RED or BLUE color fringing on the White cross, press the center MENU button to continue.

- 3 Press the MENU ring buttons to move the red or blue cross directly over the white cross on the TV screen.

The red or blue cross is properly adjusted when it is completely merged with the white cross. (No color appears around the edge of the white cross).

- 4 Press the STATUS button to clear the screen when convergence adjustments are complete.



SMART HELP



Remember. Convergence has been set at the factory for best viewing, but if one or more of the (red or blue) colors appear around the edges of objects (color fringing) follow the steps given in this section.

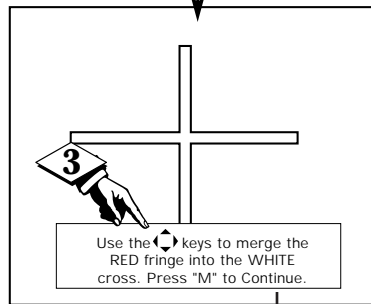
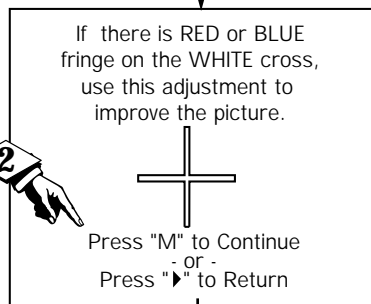
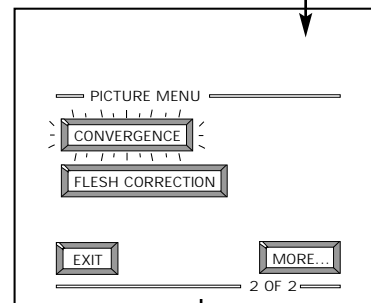
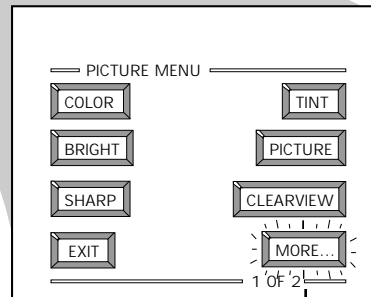
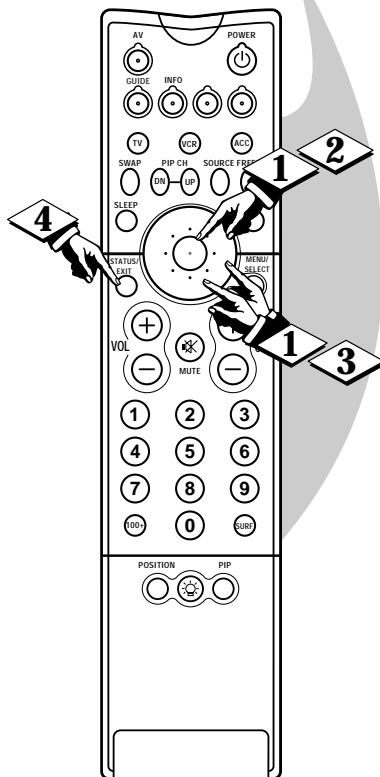
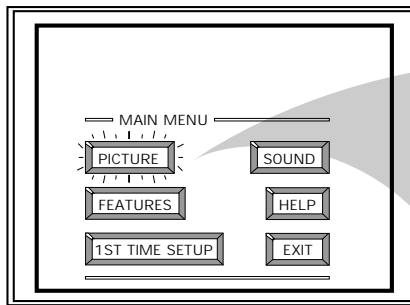

NOTE: Adjustments for "Multi-Point" on-screen color fringing can also be made as part of the TV's Convergence control system. Follow the TV's on-screen menu directions to select individual screen areas that can be readjusted and set for varying red/blue color fringing conditions. These multi-point settings can then be "Saved" to memory for the specific areas of the TV screen (or Factory Settings for convergence can be recalled and put back into place for use).

MULTI-POINT CONVERGENCE

Use the $\leftarrow\rightarrow$ keys to adjust

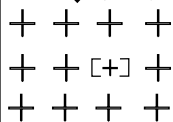

Press "M" to Adjust or Press "STATUS" to Continue

Press "M" to Save

Press $\leftarrow\rightarrow$ to Undo

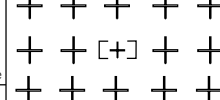

Press $\leftarrow\rightarrow$ to recall Factory Settings

FLESH CORRECTION

Use the *Flesh Correction* control to keep skin tone hues (or facial tint) from varying from TV channel to TV channel.

BEGIN

1 Select FLESH CORRECTION control.

With PICTURE MENU (2 of 2) on screen, move the RED highlight with the outer MENU ring buttons. Then press the center MENU button to select the feature.

2 Press the MENU ring buttons to move the RED highlight. Press the center MENU button to turn the FLESH CORRECTION control ON.

3 Press the STATUS button to clear the screen.

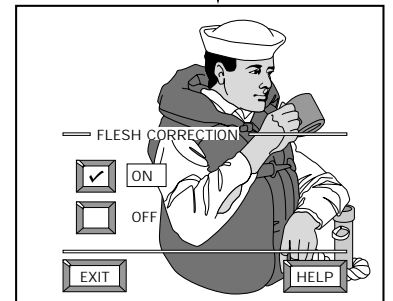
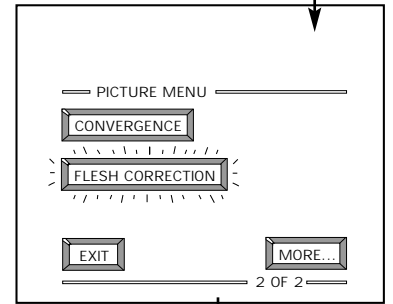
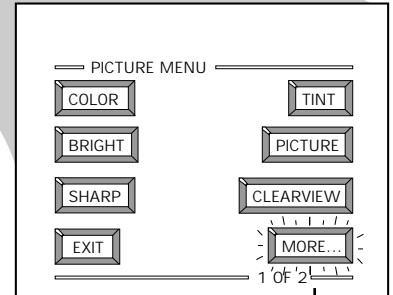
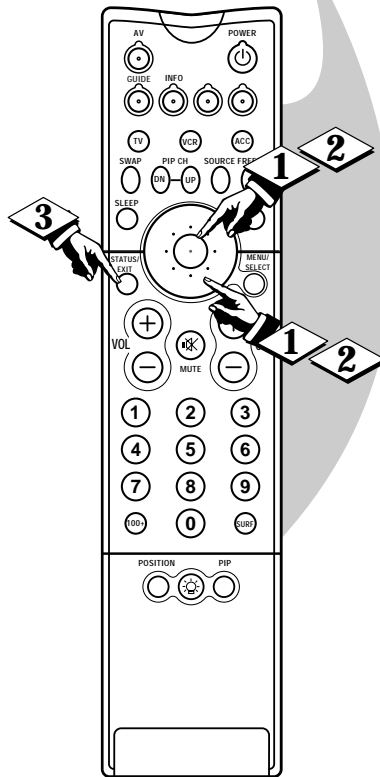
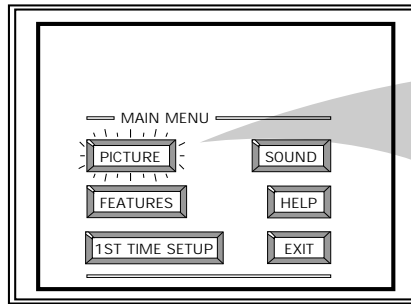

FEATURE MENU CONTROL ADJUSTMENTS

PICTURE SOURCE

The picture for the TV can come through either the ANTENNA plug or the AUDIO/VIDEO Input jacks (on the rear of the TV). The Picture Source control simply tells the TV which one of these picture sources it is to show on the TV screen.

(BEGIN)

1 Select PICTURE SOURCE SELECT control.

With the FEATURES MENU on screen, move the RED highlight with the outer MENU ring buttons. Then press the center MENU button to select the feature.

2 Press the MENU ring buttons to move the RED highlight. Press the center MENU button to turn the desired PICTURE SOURCE control ON (✓).

ANT A or B- for a picture signal coming from either the ANT(enna) A or B Input plugs on the TV.

AUX 1 (or 2) VIDEO- for a picture signal coming from the AUX 1 (or 2) Video Input jacks on the rear of the TV.

AUX 1 Y Pb Pr- for picture signals coming from the AUX 1 component (Y Pb Pr) luminance and color input jacks on the rear of the TV.

SIDE VIDEO- for a picture signal coming from the Video Input jack on the right side panel of the TV.

3 Press the STATUS button to clear the screen.

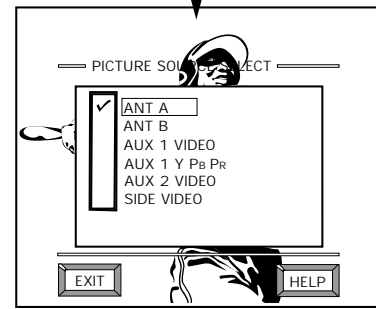
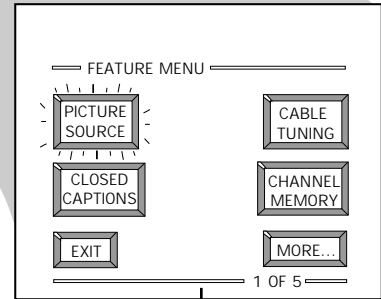
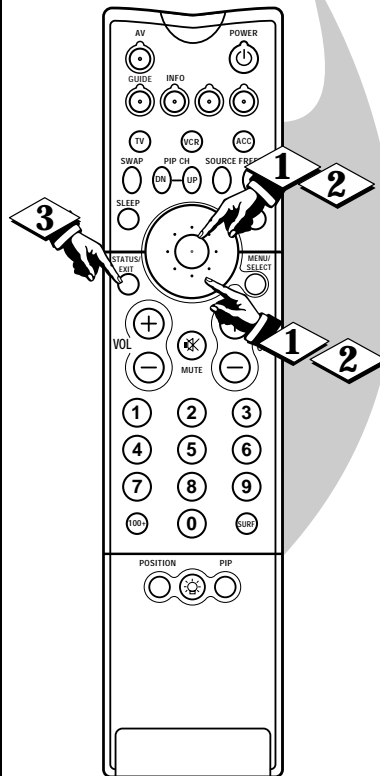
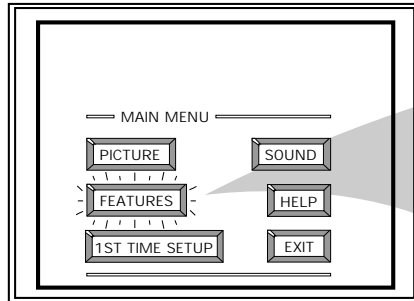

Note: A "S-VIDEO 1 (or 2)" Input control will appear as a PICTURE SOURCE SELECT(ion) in place of the AUX 1 (or 2) VIDEO position when the S-VIDEO plugs (on the rear of the TV) are connected. See page 35 for operating details on S-VIDEO.

SMART HELP



Remember, the Auxiliary Input modes (AUX 1 VIDEO, AUX 1 Y Pb Pr, etc.) must have a compatible video signal source properly connected (to the INPUT plug on the rear of the TV), or the TV screen will be blank.

CLOSED CAPTION

Closed Captioning (CC) allows you to read the voice content of television programs on the TV screen. Designed to help the hearing impaired this feature uses on-screen "text boxes" to show dialogue and conversations while the TV program is in progress.

BEGIN

1 Select CLOSED CAPTIONING control.

With the FEATURES MENU on screen, move the RED highlight with the outer MENU ring buttons. Then press the center MENU button to select the feature.

2 Press the MENU ring buttons to move the RED highlight.

Press the center MENU button to select (✓) the desired Closed Caption mode - For Example: "ALWAYS ON" and "CAPTION 1".

CAPTION 1, 2, 3, 4:

dialogue (and descriptions) for the action on the captioned TV program shows on-screen. (See Important Note on this page.)

TEXT 1, 2, 3, 4:

often used for channel guide, schedules, or bulletin board information for CC programs.

3 After making your Caption mode selection, press the STATUS button to clear the TV screen.

The selected Closed Caption mode will be active. **To cancel**, set the Closed Captioned feature to OFF when finished.



SMART HELP



Remember. Broadcast stations will often use spelling abbreviations, symbols, dropouts and other grammatical shortcuts in order to keep pace with the on-screen action. These type factors vary upon the source of the captioned text material and do not indicate a need for service on the part of the TV.

NOTE: Not all TV programs and product commercials are made for broadcast with Closed Caption (CC) information included. Neither are all Closed Caption modes (CAPTION 1-4; or TEXT 1-4) necessarily being used by a broadcast station during the transmission of a closed caption program. Usually "CAPTION 1" is the most used mode to view captioned material. Refer to your area's TV program listings for the stations and times of Closed Caption shows.

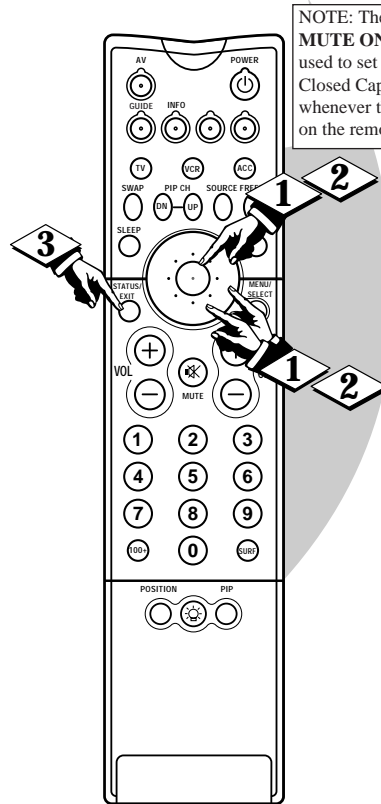
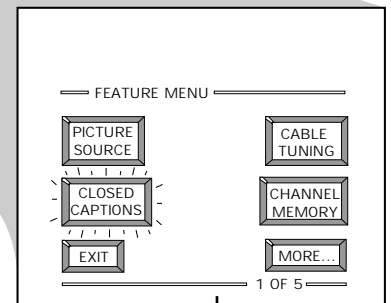
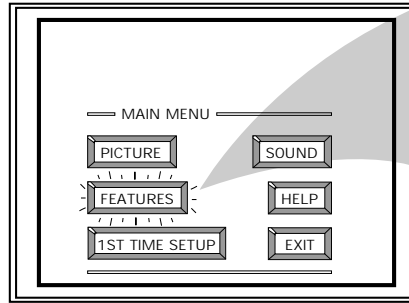

NOTE: The ON DURING MUTE ONLY control can be used to set the TV to turn the Closed Caption mode "ON" whenever the MUTE button on the remote is pressed.

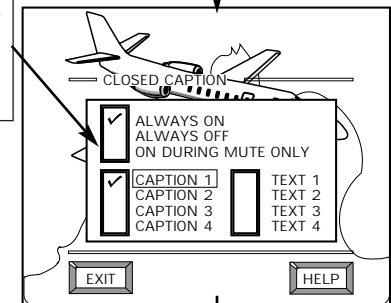

CAPTION 1 mode
Example Screen Display

Closed Caption information will usually appear in black and white (although some broadcasters or networks may occasionally use color to highlight or draw attention to certain areas.)



FULL SCREEN TEXT
will block TV screen from viewing

CABLE TUNING

You need to make sure the TV is set to pick up either Cable TV or Antenna signals. In other words, the TV needs to know if you connected a Cable TV signal or a normal antenna to its ANTENNA plug.

NOTE: If you went through First Time Setup (in your Quick Use Guide), this task has already been completed for you.

BEGIN

1 Select CABLE CHANNEL TUNING control.

With the FEATURES MENU on screen, move the RED highlight with the outer MENU ring buttons. Then press the center MENU button to select the feature.

2 Press the MENU ring buttons to move the RED highlight. Press the center MENU button to select (✓) the desired mode - For Example: CABLE.

CABLE- If you DO have Cable TV connected to the TV. Channels 1-125 available.

NORMAL- If you have an Antenna connected to the TV. Channels 2-69 available.

3 Press the STATUS button to clear the screen.

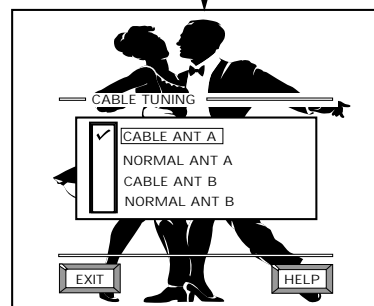
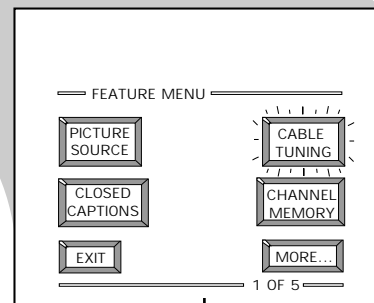
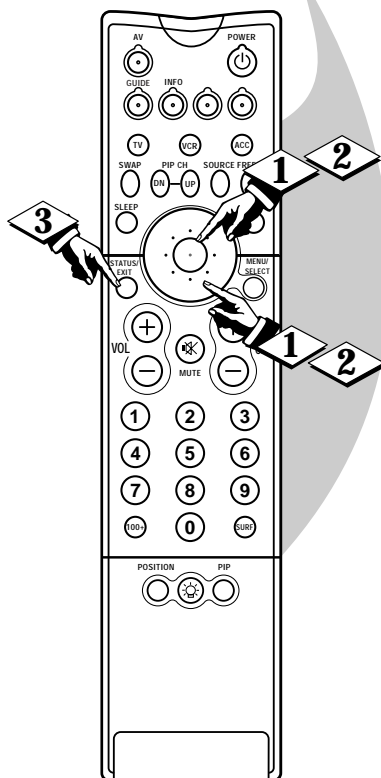
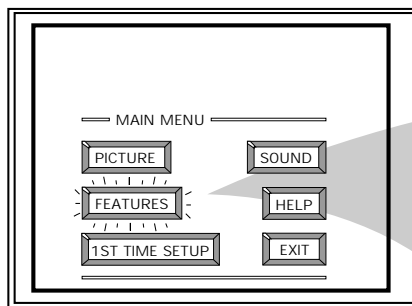

Note: Both ANT(enna) A and ANT B inputs on the rear of the TV can be set for the correct connected signal (either an Antenna or Cable TV source).

CHANNEL MEMORY AUTO-PROGRAMMING

Your TV can automatically set itself for local area (or Cable TV) channels. This makes it easy for you to select only the TV stations in your area when the CHANNEL ▲▼ buttons are pressed.

NOTE: If you went through First Time Setup (in your Quick Use Guide), this task has already been completed for you.

(BEGIN)

- 1 Select **CHANNEL MEMORY (START AUTO-PROGRAMMING)** control.

With the FEATURES MENU on screen, move the RED highlight with the outer MENU ring (◂◃) buttons. Then press the center MENU button to select the feature.

- 2 Press the center **MENU** button to turn **AUTO-PROGRAMMING ON**.

The TV shows which channel numbers are "SAVED" (✓) as they are added into memory.

"Auto-programming CHANNEL MEMORY is finished" shows when the TV is through adding channels.

- 3 Press the **STATUS** or **Menu** button to clear the screen.



SMART HELP



Try it out. Press the **CHANNEL ▲▼** buttons and see which channels you can select.

Remember, an Antenna or Cable TV signal must first be connected to your TV so that channels can be saved.

If you want to delete any unwanted channels from the TV's memory, see "ADD/DELETE CHANNELS" on the next page.

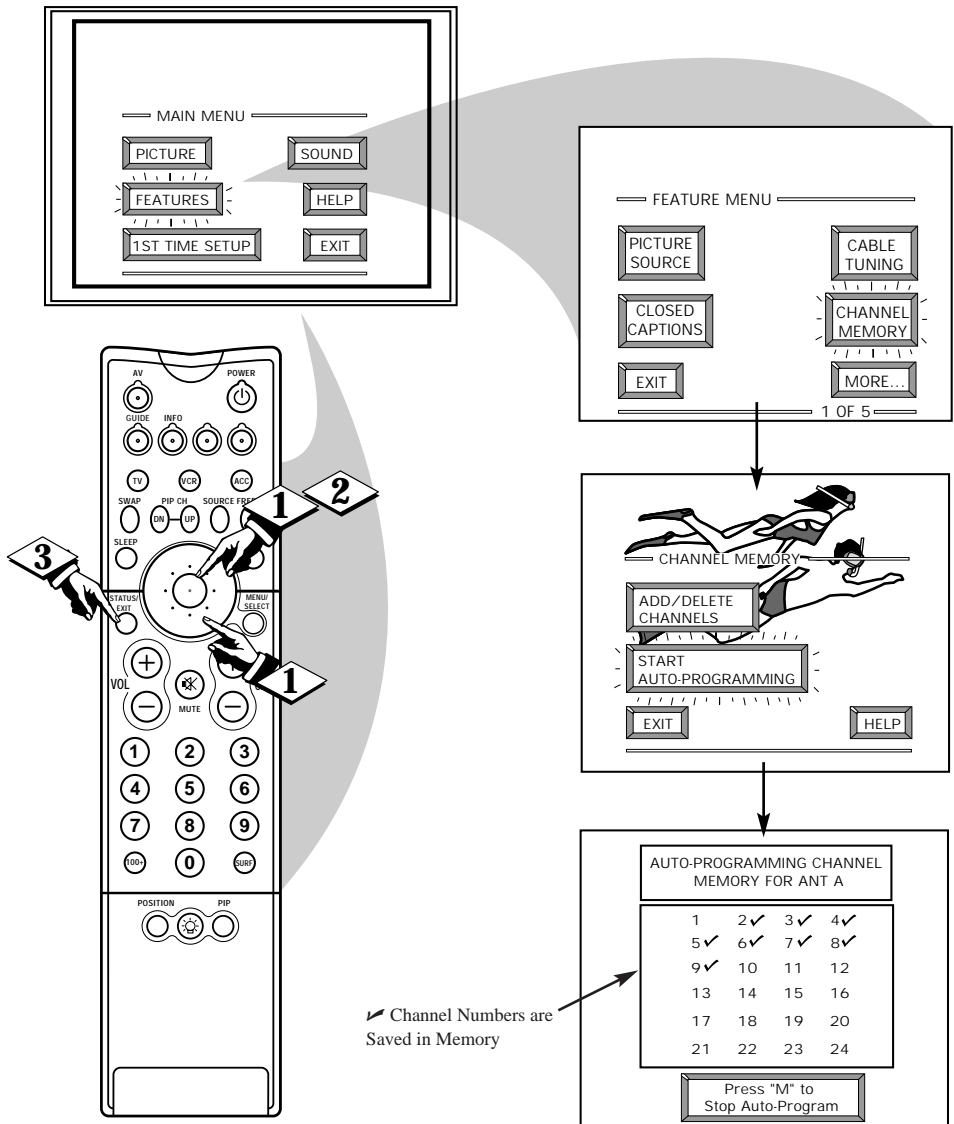

ADD/DELETE CHANNELS

Auto-Programming (see *previous page*) adds all the channels it can find (on your Antenna or Cable TV system) into the TV's memory. Add/Delete Channels makes it easy for you to add other channels, or drop unwanted channels, from the list of channels in the TV's memory.

BEGIN

- 1** Select **CHANNEL MEMORY (ADD/DELETE CHANNELS)** control.

With the **FEATURES MENU** on screen, move the **RED** highlight with the outer **MENU** ring (with the center **MENU** button) to select the feature.

- 2** Press the **CHANNEL ▲▼** or **number** buttons to select the channel you want to add or delete.

- 3** Press the outer **MENU ring** button (on the Right) to **ADD** the channel into the TV's memory.

Press the outer **MENU** ring button (on the Left) to **DELETE** the channel from memory.

Repeat steps 2 and 3 for each channel you wish to add or delete.

- 4** Press the **STATUS** or **MENU** button to clear the screen when through.



SMART HELP



Remember. You can also add the Auxiliary modes (AUX 1 VIDEO, AUX 1 Y Pb Pr, etc.) just like a channel. Then by pressing the **CHANNEL ▲▼** buttons the **AUX(iliary)** mode can quickly be selected to use the desired set of Input jacks (see page 33).

Note: **AUX(iliary)** VIDEO modes are located between the lowest and highest channel numbers within the **ADD/DELETE CHANNEL** control screen.

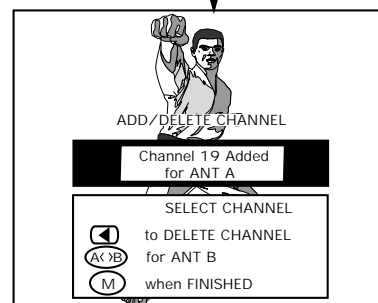
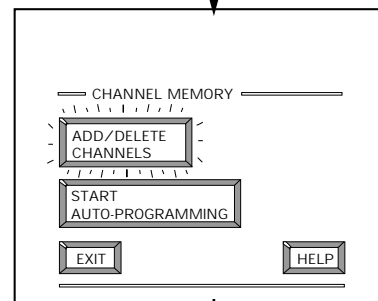
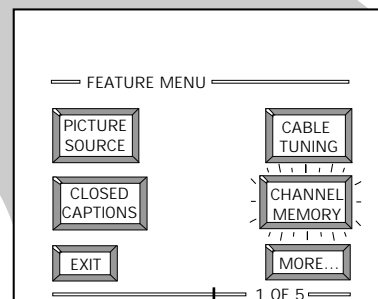
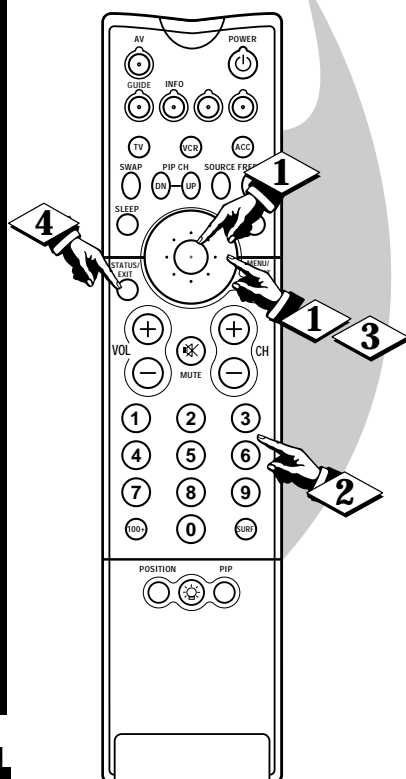
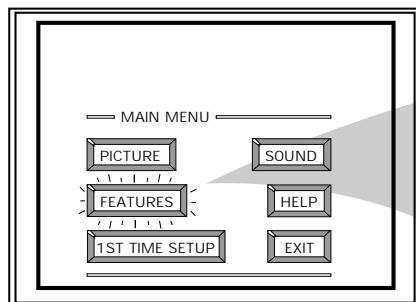

NOTE: A separate **ADD/DELETE CHANNEL** memory may also be created for the **ANT(enna) B** Input on the rear of the set (if an Antenna or Cable TV signal has been connected). Press the "AV" button on the remote, while in the **ADD/DELETE CHANNEL** mode, to switch between the **ANT A** and **ANT B** channel memory lists. Then follow steps 2 and 3 as shown to the left to add or delete the desired channels.

SET CLOCK

Your TV comes with an on-screen clock. During normal operation the clock appears on the screen with every channel change (and when the STATUS button is pressed).

BEGIN

1 Select SET CLOCK control.

With the FEATURES MENU (2 of 5) on screen, move the RED highlight with the outer MENU ring buttons. Then press the center MENU button to select the feature.

2 Press the remote's number buttons to set the time clock.

3 Press the STATUS button to set the clock in operation and clear the screen.



SMART HELP



Remember, be sure to press "0" first and then the hour number for single digit entries.

The remote's MENU ring buttons can also be used to set the hours, minutes and AM/PM portions of the clock.

TV Clock settings may be lost when the TV is unplugged (or AC power to the set is interrupted).

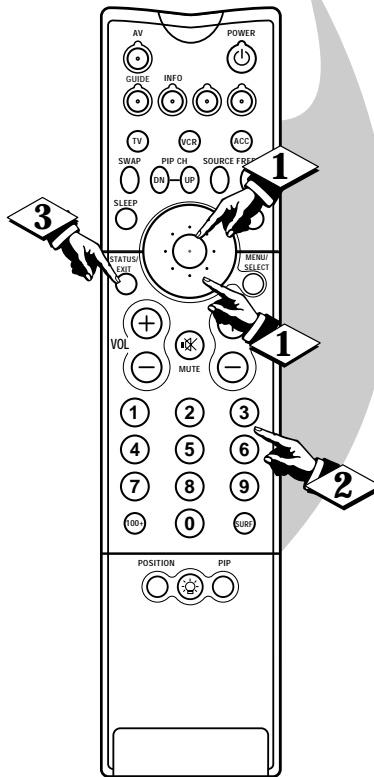
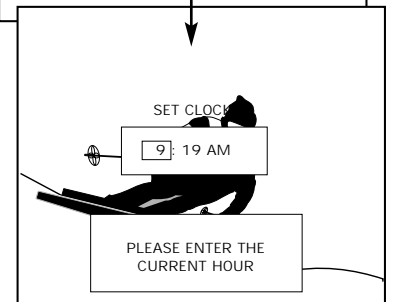
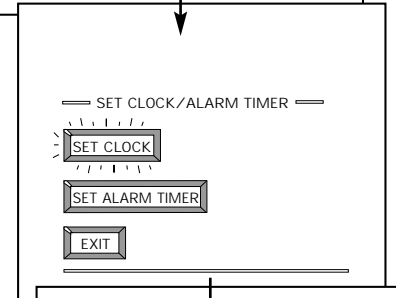
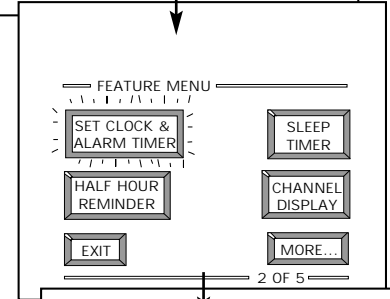
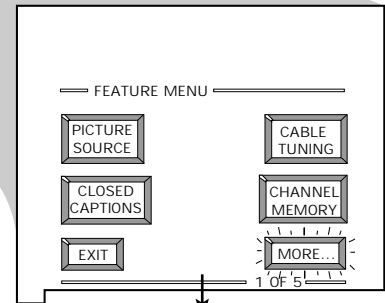
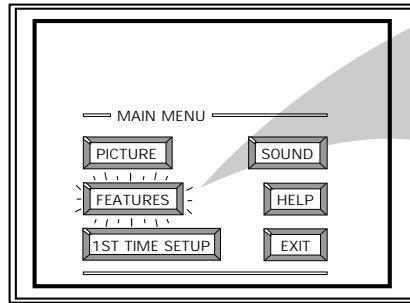

SET ALARM TIMER

Just like an alarm clock you can set the TV to turn itself on at the same time everyday.

BEGIN

- 1 Select SET ALARM TIMER control.

With the FEATURES MENU (2 of 5) on screen, move the RED highlight with the outer MENU ring buttons. Then press the center MENU button to select the feature.

- 2 Press the outer MENU ring and center MENU buttons to highlight and select "ON".

- 3 Press the outer MENU ring and center MENU buttons to select "SET ALARM TIME".

- 4 Press the remote's number buttons to set the "TURN ON" time for the TV. (Press the MENU ring buttons for the AM or PM settings.)

- 5 Press the STATUS button to set the "ALARM TIME" and clear the screen.

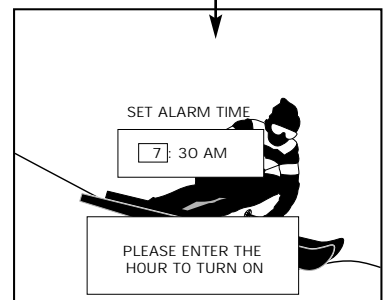
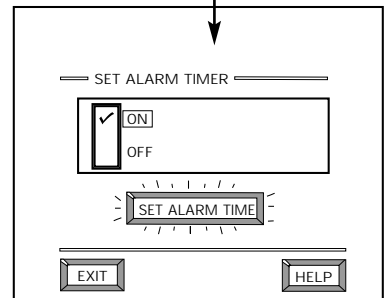
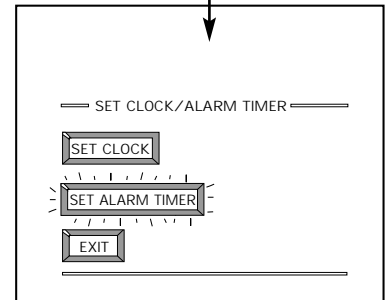
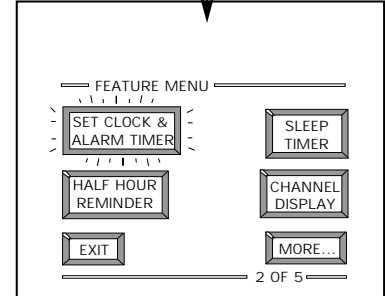
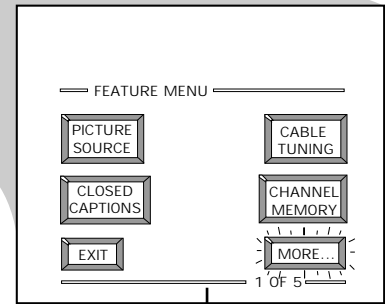
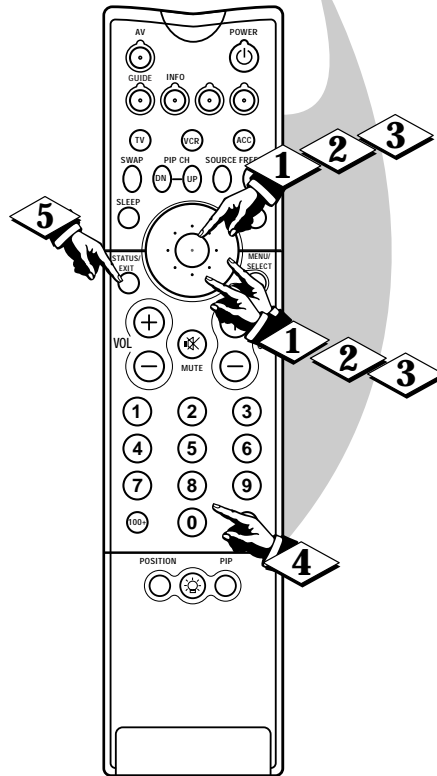
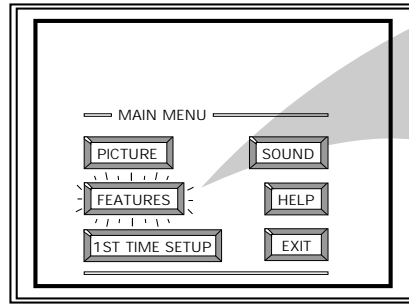



SLEEP TIMER

Have you ever fallen asleep in front of the TV only to have it wake you up at two in the morning with a test pattern screeching in your ears? Well, your TV can save you all that trouble by automatically turning itself off.

BEGIN

- 1 Press the **SLEEP** button on the remote control.

Note: you can also select the SLEEP control with the TV's on-screen FEATURES MENU (2 of 5). Move the RED highlight with the outer MENU ring buttons. Then press the center MENU button to select the feature.

- 2 Press the **SLEEP** button repeatedly to pick the amount of time (15 minutes to 2 hours ahead) before the TV will turn itself off. The Menu ring buttons can also be used to set the amount of time.

- 3 Press the **STATUS** or **MENU** button to clear the screen after you have set the time for the TV to turn off.



SMART HELP



Remember, to see how many minutes are left before the TV shuts itself off, reselect the SLEEP TIMER control screen.

To stop a SLEEP TIMER setting, reset the timer back to OFF. (Turning the TV off and on, or pressing a button during the last minute of a timer setting, will also cancel a setting.)

A few seconds before the TV is to shut off a message will come on the screen telling you *GOOD NIGHT*.

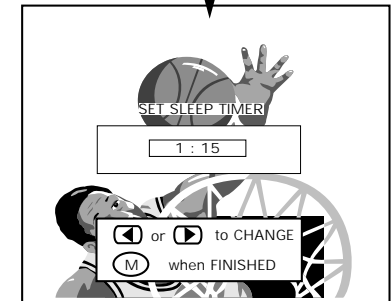
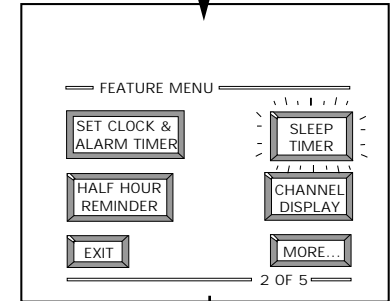
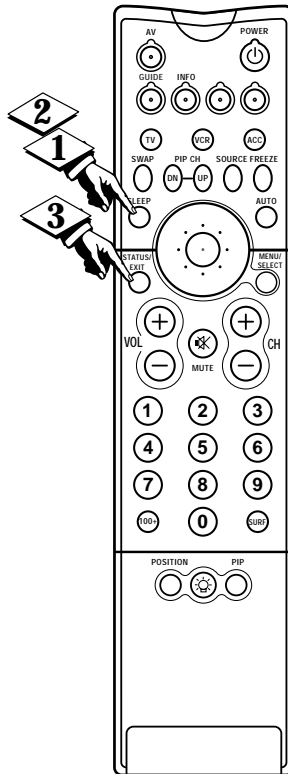
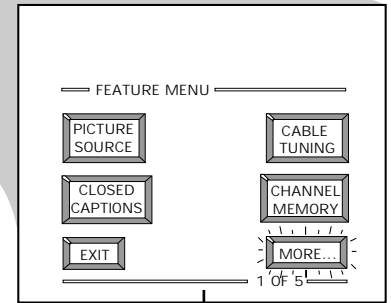
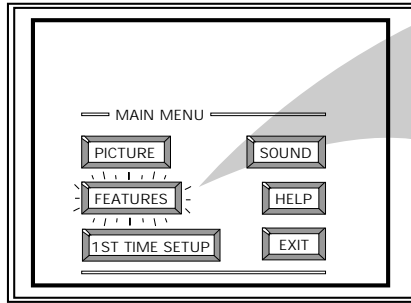

FEATURE MENU CONTROLS (CONTINUED)

CHANNEL DISPLAY

With the Channel Display control you can change the size and location of the on screen channel and clock information.

(BEGIN)

- 1 Select CHANNEL DISPLAY control.

With the FEATURES MENU (2 of 5) on screen, move the RED highlight with the outer MENU ring buttons. Then press the center MENU button to select the feature.

- 2 Press the MENU ring and center MENU buttons to highlight and select (✓) the LARGE or SMALL display size control.

- 3 Press the STATUS button to clear the screen.

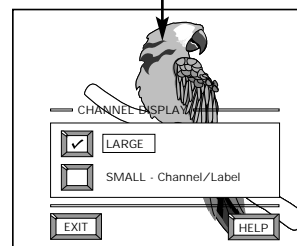
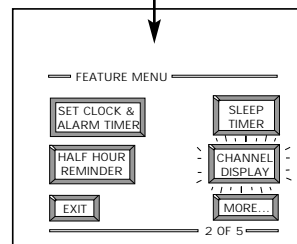
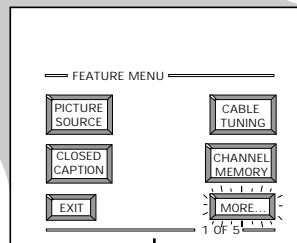
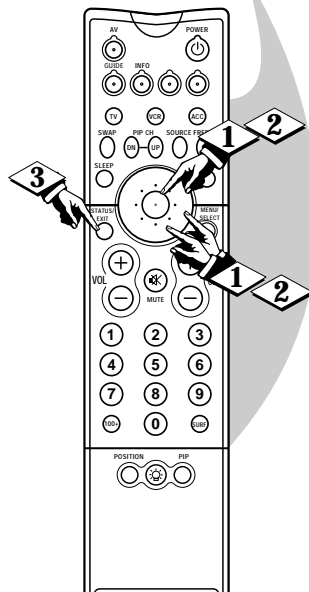
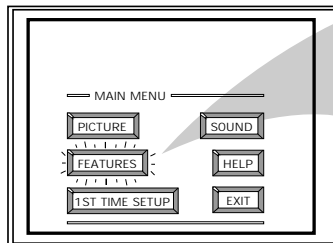

SMART HELP



Try it out. Press the CHANNEL ▲▼ buttons and you should see the Display Size you selected.

Remember. The SMALL SIZE display shows only the channel number, not the time (or clock).

HALF HOUR REMINDER

With the Half Hour Reminder control the TV automatically shows you the current time and channel every thirty minutes.

(BEGIN)

- 1 Select HALF HOUR REMINDER control.

With the FEATURES MENU (2 of 5) on screen, move the RED highlight with the outer MENU ring buttons. Then press the center MENU button to select the feature.

- 2 Press the MENU ring and center MENU buttons to highlight and select (✓) the EVERY HALF HOUR item.

- 3 Press the STATUS button to clear the screen.

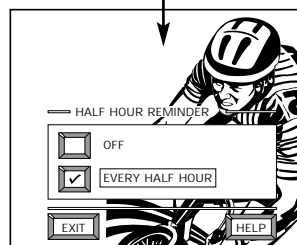
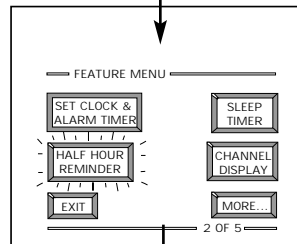
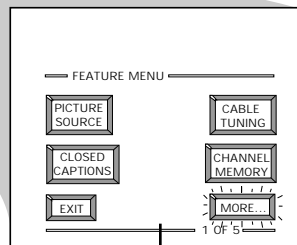
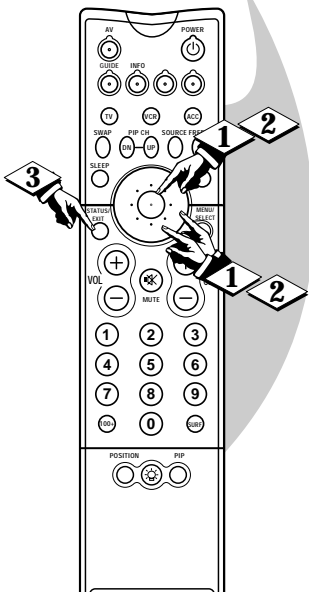
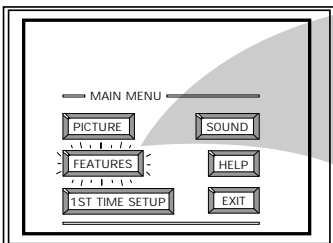

SMART HELP



Remember. The Time and Channel Reminders will show on the hour and the half-hour for about five seconds.

PARENTAL CONTROL SETUP CODE NUMBER

Parental Control allows parents to block out, or "censor", any channels they think children should not watch. A channel placed under Parental Control cannot be viewed until a correct access code is used to unlock the channel for viewing.

First let's set your Parental Code:

(BEGIN)

1 Select the PARENTAL CONTROL.

With the FEATURES MENU (3 of 5) on screen, move the RED highlight with the outer MENU ring buttons. Then press the center MENU button to select the feature.

"CHANNEL BLOCKING" and "SETUP CODE" show on screen.

2 Press the MENU ring and center MENU buttons to highlight and select the SETUP CODE item.

3 Press 0, 7, 1, 1 on the remote.

"XXXX" shows on the ACCESS CODE SETUP screen as you press the number buttons.

"INCORRECT ACCESS CODE - TRY AGAIN" will also show on the screen.

4 Press 0, 7, 1, 1 on the remote again.

"Next Enter Your New Access Code" shows on the screen.

5 Enter a new four digit number code using the remote.

"Access Code Changed" shows on the screen to let you know the new code has been set.

Continue to the next page to find out how to "BLOCK" channels from viewing.

NOTE: Your TV left the factory with the Parental Code set to "0000". If you are using your TV and the Parental Control for the first time, and don't want to SETUP a new Access code number, you can use the "0000" number to block channels - see next page. The "0711" Parental Code (shown on this page) is given as a default or way to reset the Code when the current Access number is not known.

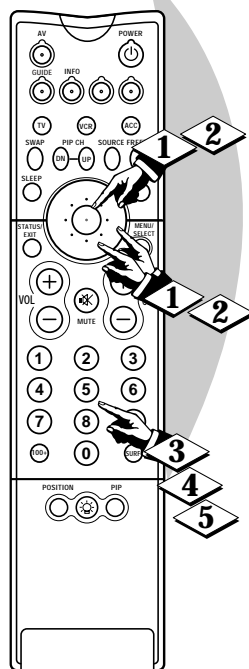
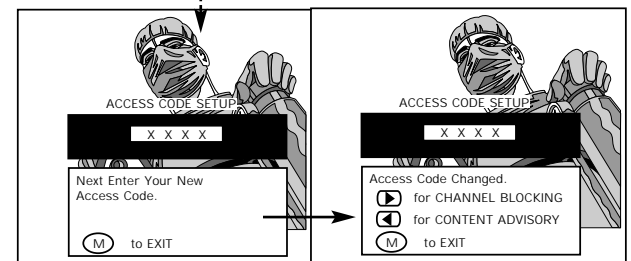
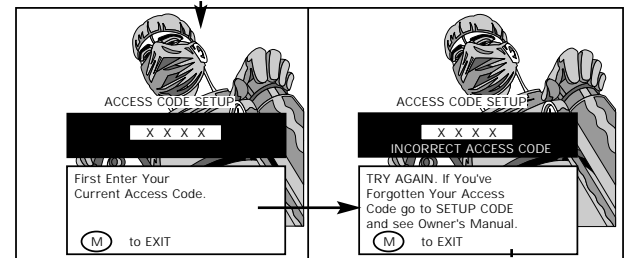
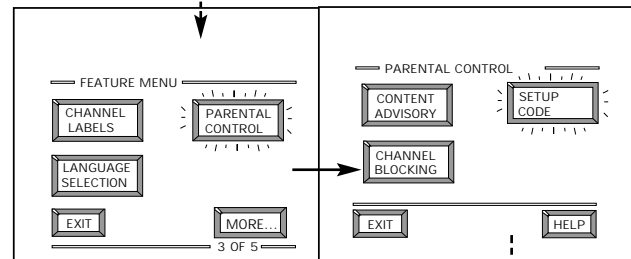
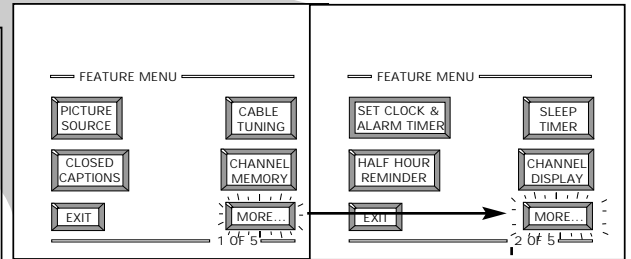
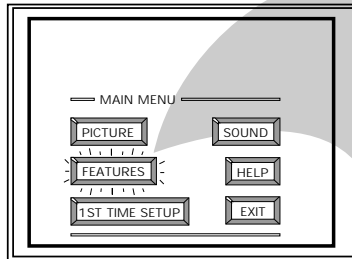

- Press outer MENU ring button (on the Right) to go on and start to "block" channels.
- Press outer MENU ring button (on the Left) to go to "Content Advisory" (or TV and Movie Ratings system of channel blocking).
- Press the center MENU button to return to the Parental Control Menu screen.
- Press STATUS to clear the screen.

SMART HELP



Parents - it isn't possible to unlock or defeat your Censor Code without changing to a new code number. So if your Code number changes, and you didn't change it yourself, then you will know that someone has altered the code and the blanked out channel has been viewed.

PARENTAL CONTROL CHANNEL BLOCKING

After your personal Parental Code number has been set (see previous page), you are now ready to select the channels you want to block out or censor.

BEGIN

1 Select the **BLOCK CHANNELS** control.

With the FEATURES MENU (3 of 5) on screen, move the RED highlight with the outer MENU ring buttons. Then press the center MENU button to select the feature.

2 Press the MENU ring and center MENU buttons to highlight and select the CHANNEL BLOCKING item.

3 Enter the correct Parental Code number.

4 Press Channel ▲▼ or Channel Number buttons to select the channel you want to block.

5 Press the outer MENU ring button (on the right) to "BLOCK VIEWING" on the selected channel.

Press the outer MENU ring button (on the left) to "ALLOW VIEWING" on a blocked channel.

Repeat steps 3 and 4 for any other channels you wish to block out.

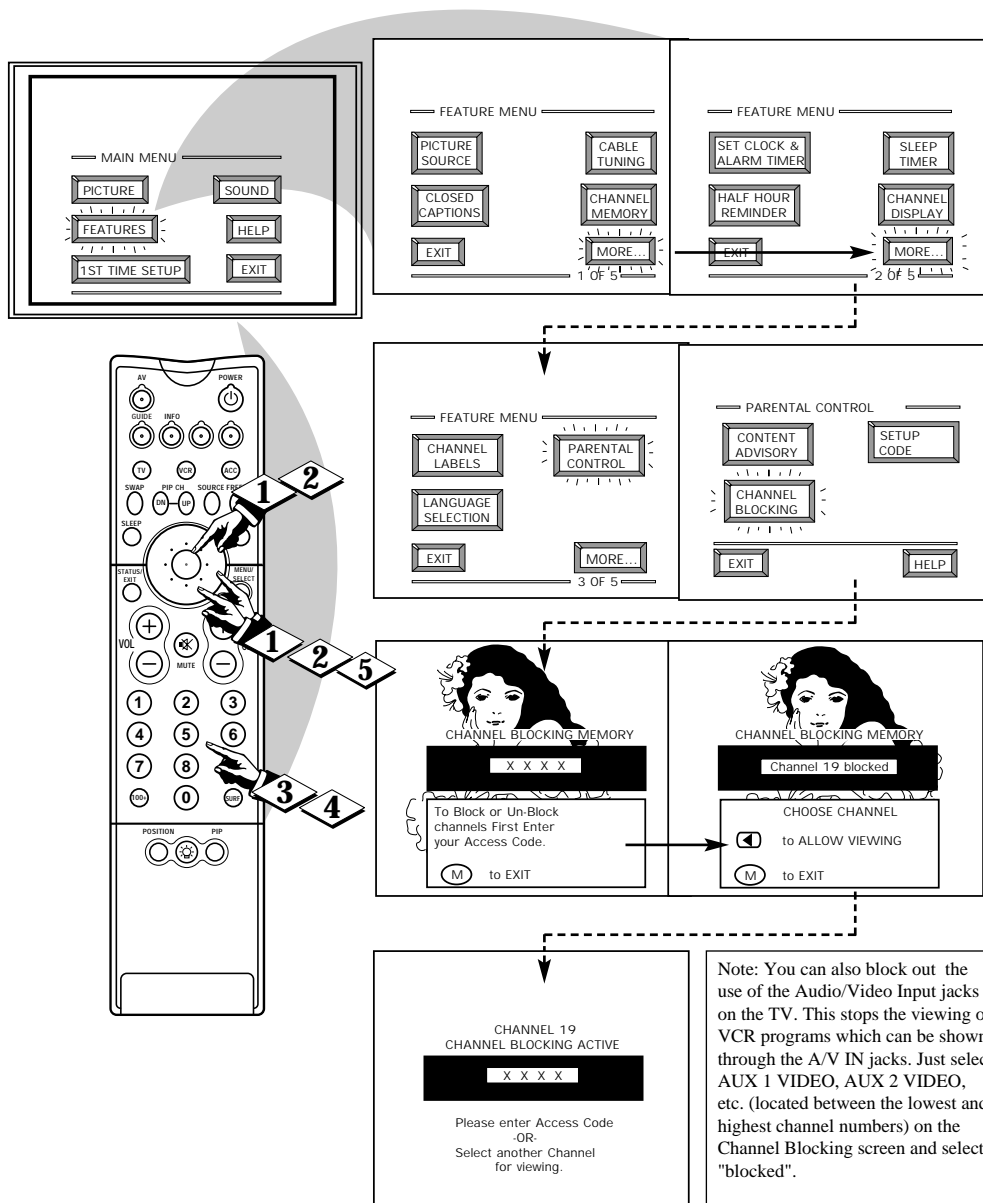

BLOCKED CHANNEL SCREEN MESSAGE
(Appears when an attempt to select a blocked channel is made and Parental Control is ON.)

SMART HELP



Remember, once set Parental Control blocks out the selected channel number on both the ANT A and ANT B channel rings. Also, to make TV viewing easier all channels (for both ANT A/B and Audio/Video Input jacks) will be unblocked, once the correct Parental Code number has been entered.

When the TV is turned OFF and then back ON again, is when Parental Control is back in place for all blocked out channels.

PARENTAL CONTROL

CONTENT ADVISORY

Another new area available to parents for the censoring of program material is through the TV Guidelines and Movie Ratings system. Program Content Advisory data will soon be contained within the broadcast signals of received TV programs. When setup by the parent or viewer, the TV can respond to transmitted advisory data by blocking out or denying access to TV shows (based on whether the program meets or exceeds the limitations you select as viewable). The TV program can then only be viewed by entering the correct and current Parental Code Access number.

The Content Advisory system uses both "Movie Ratings" and a "Parental Guidelines" form of censoring. Refer to the following page sections for explanations on the different Rating system levels and their uses.

BEGIN

1 Select the CONTENT ADVISORY Menu option

With PARENTAL CONTROL Menu on screen, move the RED highlight with the outer MENU ring buttons. Then press the center MENU button to select the feature.

A Parental Guideline/Movie Rating status screen will appear with a review of currently BLOCKED Content Advisory categories.

2 Press the outer MENU ring button (on the right) to select the ENTER ACCESS CODE Menu item.

3 Enter the correct Parental Code number (see note at the top of this page).

"CONTENT ADVISORY" Menu screen appears. Parental Guidelines, Movie Ratings and other blocking control items are ready for selection and use.



Note: Please remember that a valid and current Access Code number will be required in the setup and use of the TV's "Content Advisory" system. Review the previous **SETUP CODE** section on how to obtain a valid Parental Access Code number before attempting to make adjustments within the Movie Ratings and Parental Guidelines system.

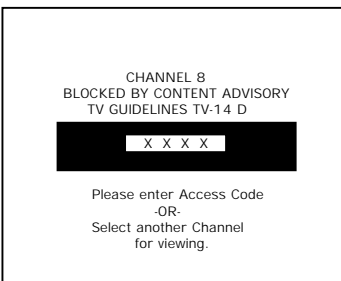
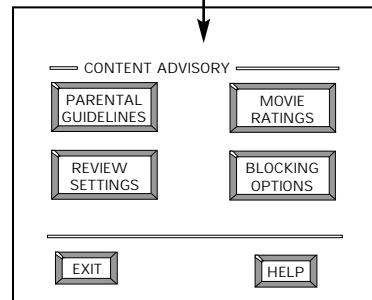
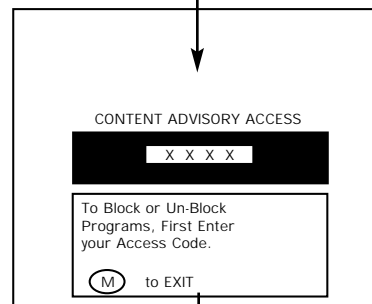
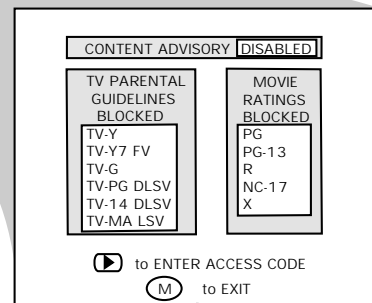
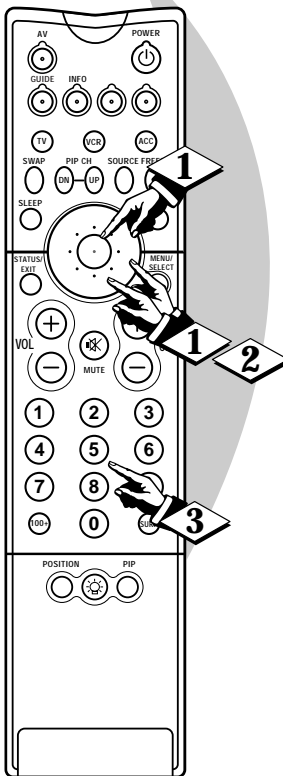
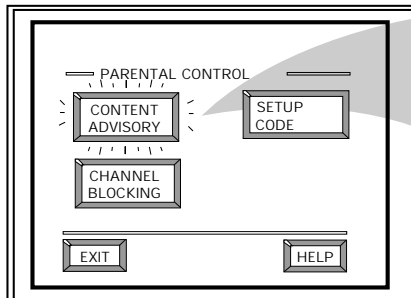

NOTE: In normal Content Advisory system operation the TV screen will display a message when programming is blocked by a Movie Rating, Parental Guideline, or Blocking Option control feature. Entering the correct ACCESS CODE number will unblock all the blocked Content Advisory Rated channels until the TV is turned Off. The blocked Advisory Ratings will be back in place when the TV is turned back On again.

CONTENT ADVISORY MOVIE RATINGS

Movie Ratings set viewing access levels for TV programming according to current Motion Picture Association of America (MPAA) ratings. These ratings are similar to the categories used with the rated movies appearing in cinema theaters and with video rental material.

BEGIN

1 Select the MOVIE RATINGS Menu option.

With CONTENT ADVISORY Menu on screen, move the RED highlight with the outer MENU ring buttons. Then press the center MENU button to select the feature.

2 Press the MENU ring and center MENU buttons to highlight and select (✓) the desired MOVIE BLOCKING level.

When in operation a “Blocked - Movie Rating” TV screen appears when movies are received which include the same selected rating as the Movie Blocking setting(s). Only the correct Access Code number, entered by the viewer, will unblock or allow the viewing of a block rated program.

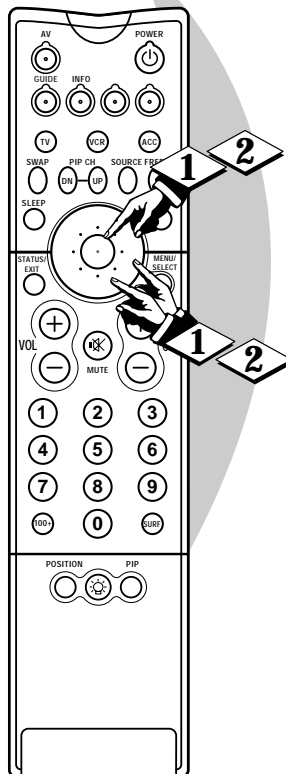
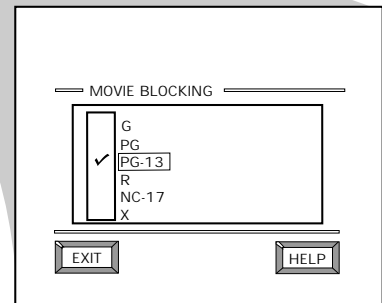
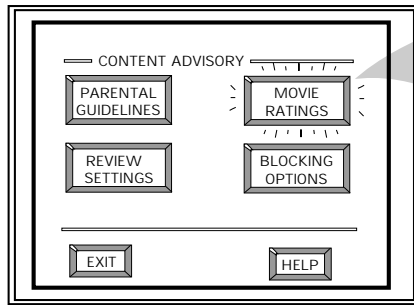

- **G - General Audience:** Most parents would find this program suitable for all ages. This type of programming contains little or no violence, no strong language, and little or no sexual dialogue or situations.
- **PG - Parental Guidance:** This programming contains material that parents may find unsuitable for younger children. It may contain one or more of the following: Moderate violence, some sexual situations, infrequent coarse language, or some suggestive dialogue.
- **PG-13:** This programming contains material that parents may find unsuitable for children under the age of 13. It contains one or more of the following: violence, sexual situations, coarse language, or suggestive dialogue.
- **R - Restricted:** This programming is specifically designed for adults. Anyone under the age of 17 should only view this programming with an accompanying parent or adult guardian. It contains one or more of the following: intense violence, intense sexual situations, strong coarse language, or intensely suggestive dialogue.
- **NC-17 - No one under 17 admitted:** This type of programming should be viewed by adults only. It contains graphic violence, explicit sex, or crude indecent language.
- **X - Mature audience only:** This type of programming contains one or more of the following: very graphic violence, very graphic and explicit or indecent sexual acts, very coarse and intensely suggestive language.

SMART HELP



Note: When a Movie Rating is selected (✓) all higher level ratings are automatically blocked (although each individual Movie Rating can be manually selected and turned On or Off as desired). Programs with lower than the selected rating level are allowed for viewing or unblocked.

CONTENT ADVISORY PARENTAL GUIDELINES

Parental Guidelines can be even more defined and specific in the degree and extent of material parents may allow for TV program viewing. Sub-settings for Language, Violence, and other blocking factors can be manually switched On or Off for use within the major Parental Guideline categories (TV-Y7, TV-PG, etc.).

(BEGIN)

1 Select the PARENTAL GUIDELINES Menu option.

With CONTENT ADVISORY Menu on screen, move the RED highlight with the outer MENU ring buttons. Then press the center MENU button to select the feature.

2 Press the MENU ring (Left and Right side) buttons to highlight and select the desired PARENTAL GUIDELINE rating level (TV-Y, TV-Y7, etc.).

3 Press the MENU ring and center MENU buttons to Block (✓) the selected Parental Guideline category (or to set other individual blocking feature items available within that Guideline category (L, V, S, D, etc.) as desired).

Note: Selecting "ALWAYS BLOCKED" (or individually adjusting the L, V, S, D settings) for any one rating will set all other higher level ratings to be automatically blocked as well.



SMART HELP



The TV-Y7; TV-PG; TV-14; and TV-MA guidelines also include customized settings for various additional items such as V (violence), S (sexual situations), L (coarse language), D (suggestive dialogue), and FV (fantasy violence). These additional settings are category specific and can be individually selected for use as desired.

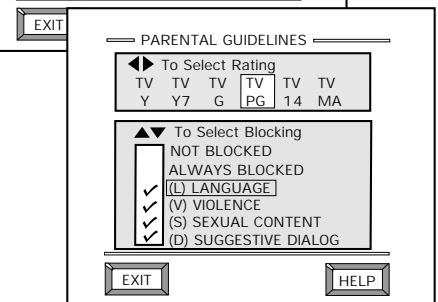
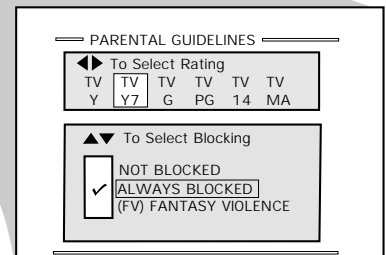
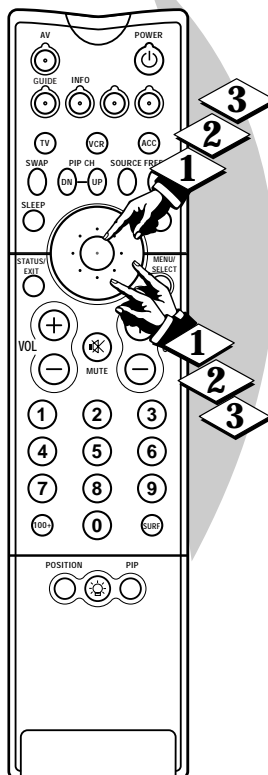
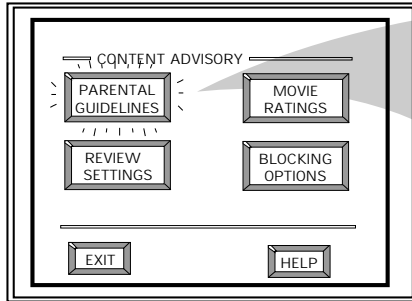

- **TV-Y - Appropriate for all children:** Designed for a very young audience, including children ages 2-6. This type of programming is not expected to frighten younger children.
- **TV-Y7 - Appropriate for children seven and older:** It may be more appropriate for children who have acquired the development skills needed to distinguish between make-believe and reality. This programming may include mild fantasy and comic violence (FV).
- **TV-G - General Audience:** This type of programming contains little or no violence, no strong language, and little or no sexual dialogue or situations.
- **TV-PG - Parental Guidance suggested:** This type of programming contains one or more of the following: Moderate violence (V), some sexual situations (S), infrequent coarse language (L), or some suggestive dialogue (D).
- **TV-14 - Unsuitable for children under 14:** This type of programming contains one or more of the following: intense violence (V), intense sexual situations (S), strong coarse language (L), or intensely suggestive dialogue (D).
- **TV-MA - Mature audience only:** This type of programming contains one or more of the following: graphic violence (V), explicit sexual situations (S), or crude indecent language (L).
- **(V) - Violence**
- **(S) - Sexual situations**
- **(L) - Language**
- **(D) - Inappropriate dialogue**
- **(FV) - Fantasy Violence** may frighten children under seven. Some cartoons may have this rating. Available in the TV-Y7 category only.

FEATURE MENU CONTROLS (CONTINUED)

CONTENT ADVISORY BLOCKING OPTIONS

The Content Advisory system also has “Blocking Option” controls which can be used to deny viewing access for channel programs and movies even when they are “unrated”, or contain “no rating” information as broadcasted.

BEGIN

1 Select the **BLOCKING OPTIONS** Menu control.

With CONTENT ADVISORY Menu on screen, move the RED highlight with the outer MENU ring buttons. Then press the center MENU button to select the feature.

2 Press the MENU ring and center MENU buttons to turn the Blocking System On (highlight and select ENABLED). Then use the remote Menu buttons to select the desired programming and information blocking options.

Please refer to Note shown with this page section for details on “unrated” and “no rating” program control options.

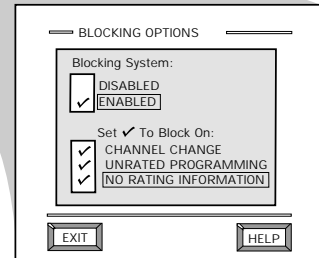
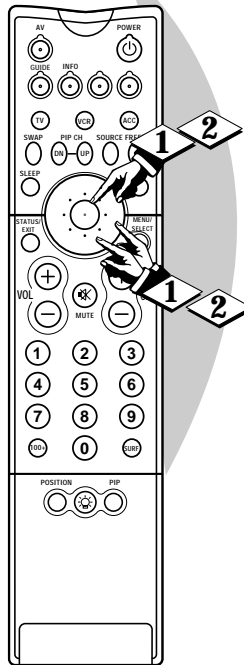
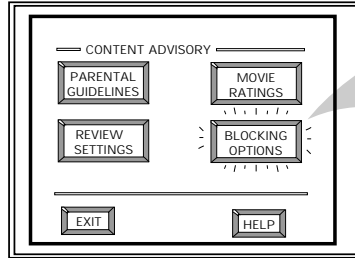

Note: Remember that Content Advisory data or encoded information is not available with all received TV programming (this also includes commercials, and other program spot announcements). Broadcaster’s can decide **not to encode** any kind of content advisory ratings with their programming, or they can actually choose to **encode programs to be “unrated.”**

The TV Blocking Options allow the viewer to block any program without content advisory data with the use of its “NO RATING INFORMATION” control. And to block programs that are encoded as “unrated” with its “UNRATED PROGRAMMING” control option.

Since the reception of Content Advisory data can take a few seconds, you may want to use the “CHANNEL CHANGE” option to be sure no viewing is allowed during blocked program channel changes. This can eliminate the display of a few seconds of undesirable video on the TV, or receiving scenes from a Ratings blocked channel source.

CONTENT ADVISORY REVIEW SETTINGS

Use the Review Settings control to quickly check the status for Content Advisory system Parental Guidelines and Movie Rating “Blocked” program levels.

BEGIN

1 Select the **REVIEW SETTINGS** Menu option.

With CONTENT ADVISORY Menu on screen, move the RED highlight with the outer MENU ring buttons. Then press the center MENU button to select the feature.

The TV screen will display the current Parental Guideline and Movie Ratings Blocked program settings. Content Advisory system status will also be shown (Enabled -On, or Disabled - Off).

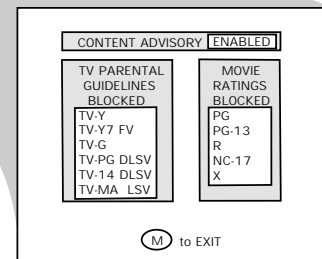
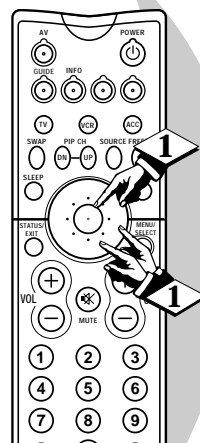
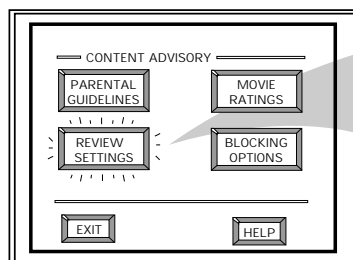

CHANNEL LABELS

Do you ever have trouble remembering on which channel a particular station or network is located? The Channel Labels Control is a quick way to view and select channels from a list of Labeled channels.

A Label is a four letter callout you can set to appear with the on screen channel number. Example Label: WXYZ - for a TV station's call letters.

To select channels from the Channel Labels Control:

BEGIN

1 With the **FEATURE MENU** (3 of 5) on the TV screen, move the **RED** highlight with the outer **MENU** ring buttons. Then press the center **MENU** button to select **CHANNEL LABELS**.

2 Press the **MENU** ring and center **MENU** buttons to highlight and select either:
 "MANUAL" to create your own label for a channel.
 "PRESETS" to choose from a list of prewritten channel labels.
 (See instruction details on this page.)

3 Press the **STATUS** button to clear the screen.

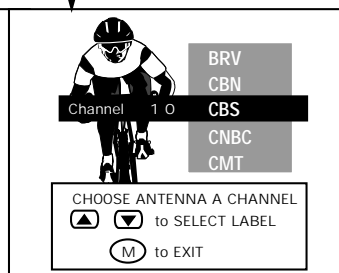
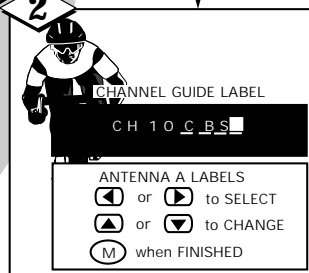
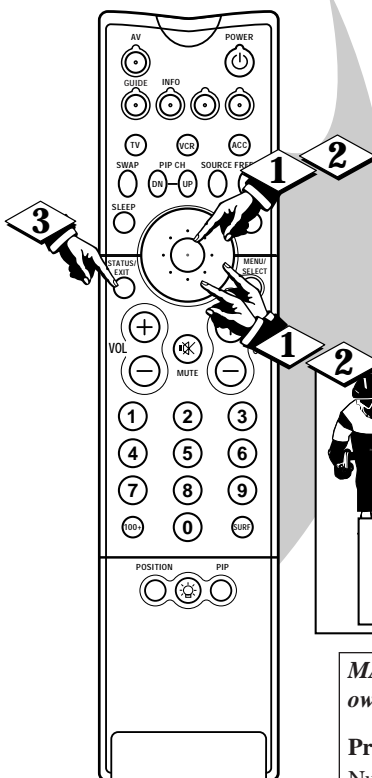
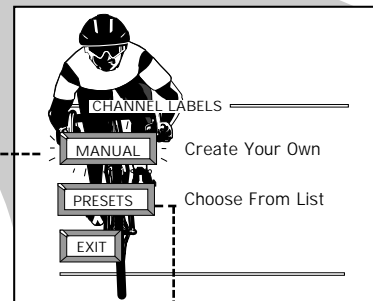
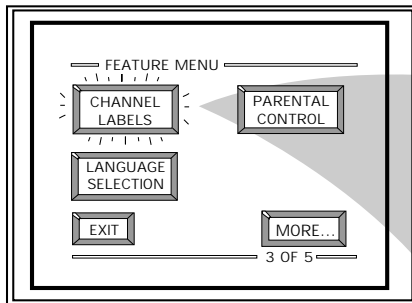

MANUAL- To create your own Channel Label:

Press the Channel **▲▼** or Number buttons to select desired station.

A **red highlight** shows the active letter space for the channel label.

Press the outer **MENU ring (top or bottom)** buttons on the remote to pick any of the letters or symbols that are given for your use.

Press the outer **MENU ring (Left and Right)** buttons on the remote to move the red highlight to the other letter spaces and repeat.

Press the **STATUS** button to clear the screen when finished.

PRESETS -To pick a Label from the "LABEL" list:

Press the Channel **▲▼** or Number buttons to select desired station.

Press the outer **MENU ring (top or bottom)** buttons to move up and down the Channel Label list.

Just stop on any label you might want to use.

The selected label automatically appears with channel changes and when the **STATUS** button is pressed.

Press the **STATUS** button to clear the screen when finished.

FEATURE MENU CONTROLS (CONTINUED)

LANGUAGE

Note: If you went through First Time Setup, This task has already been completed for you.

For our Spanish and French speaking TV owners an on-screen LANGUAGE option is present. With the LANGUAGE control you can set the TV's on-screen features to be shown in either English, Spanish or French.

BEGIN

1 Select the LANGUAGE DISPLAY control.

With FEATURES MENU (3 of 5) on screen, move the RED highlight with the outer MENU ring buttons. Then press the center MENU button to select the feature.

2 Press the MENU ring and center MENU buttons to highlight and select (✓) English, Español, or Français on the display control.

Text for the on-screen Menu will change to the selected language.

3 Press the STATUS button to clear the screen.



SMART HELP



Remember, the Language control only makes the TV's on-screen (MENU) items appear in English, Spanish, or French text. It does not change the other on-screen text features such as Closed Captioned (CC) TV shows.

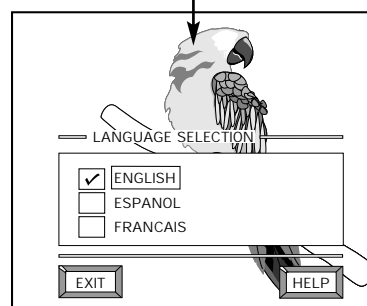
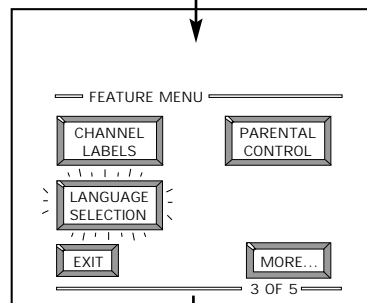
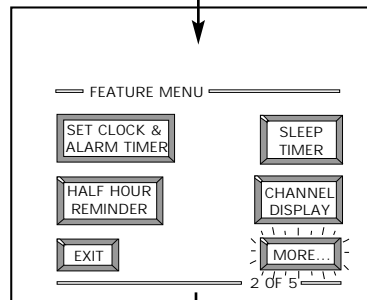
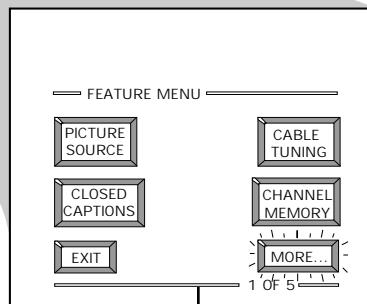
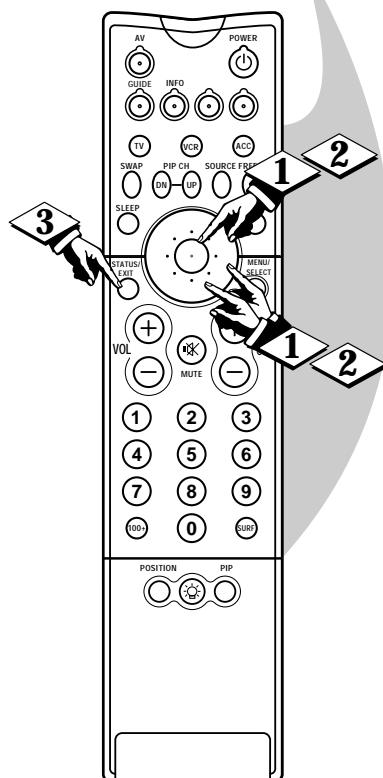
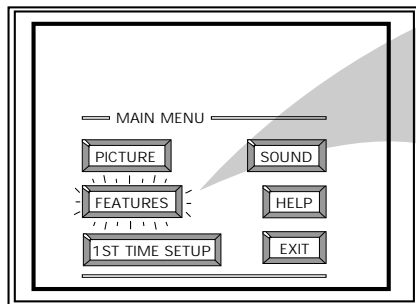

BASS, TREBLE, BALANCE

Your TV also has individual sound adjustment controls. The **BASS** (low frequency), **TREBLE** (high frequency), and **Speaker BALANCE** may all be used to adjust the sound playback of TV programs.

BEGIN

- 1 Select **BASS**, or **TREBLE**, or **BALANCE** sound control.

With the **SOUND MENU** on the screen, move the **RED** highlight with the outer **MENU** ring buttons. Then press the center **MENU** button to select the feature.

- 2 Press the outer **MENU ring (Left and Right)** buttons to adjust the sound control to levels you prefer.

- 3 Press the **STATUS** button to clear the screen.

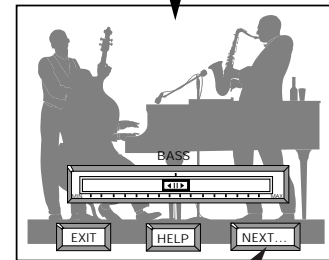
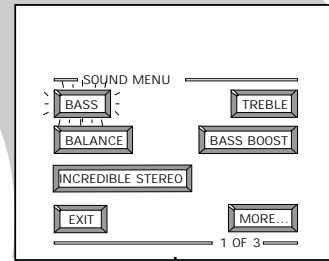
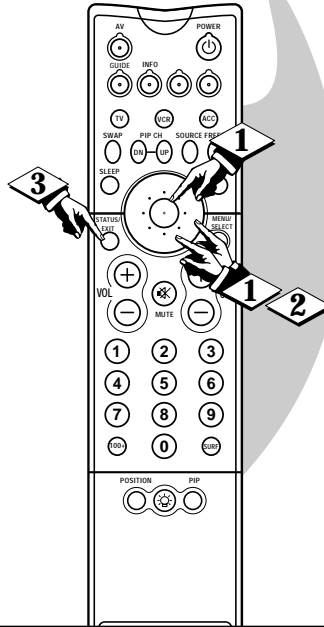
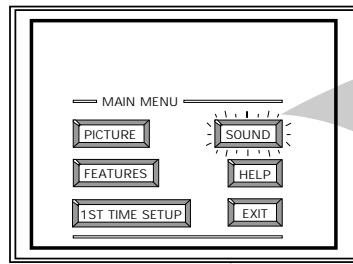

Select and then press **MENU (M)** button to view additional controls grouped under same feature heading. For Example: Treble, Balance, Bass Boost, Stereo, etc.

BASS BOOST

The **BASS BOOST** control increases the low frequency audio range of the TV. This creates a deeper, fuller playback sound which can be heard through the TV's speakers.

BEGIN

- 1 Select **BASS BOOST** sound control.

With the **SOUND MENU** on the screen, move the **RED** highlight with the outer **MENU** ring buttons. Then press the center **MENU** button to select the feature.

- 2 Press the **MENU ring and center MENU** buttons to highlight and turn **ON** (✓) the **BASS BOOST** control.

- 3 Press the **STATUS** button to clear the screen.

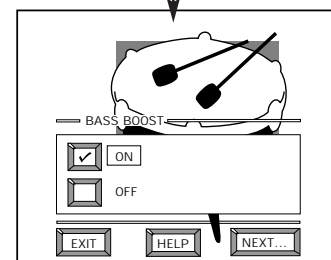
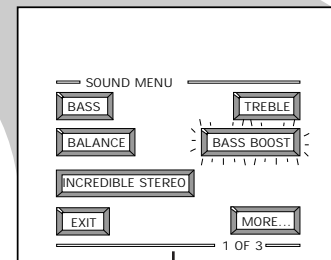
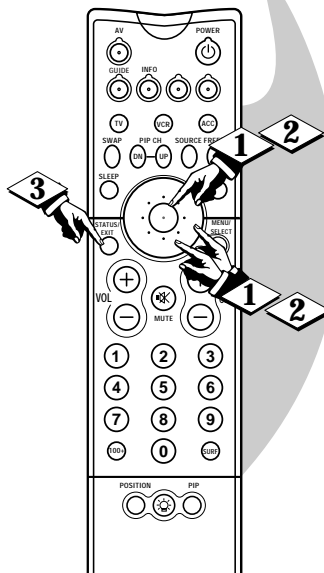
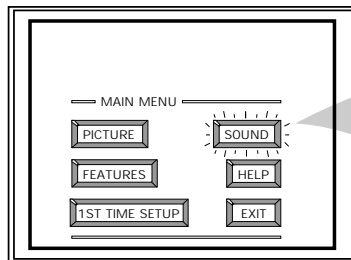

SOUND MENU CONTROLS (CONTINUED)

STEREO

Your TV is able to receive broadcast stereo TV programs. The TV is equipped with an amplifier and twin speaker system through which the stereo sound can be heard.

Note: STEREO will appear on the TV's channel status screen to indicate when a stereo broadcast signal is available and received.

BEGIN

- 1 Select **STEREO** sound control. With the **SOUND MENU** on the screen, move the **RED** highlight with the outer **MENU** ring buttons. Then press the center **MENU** button to select the feature.
- 2 Press the **MENU** ring and center **MENU** buttons to highlight and turn ON (✓) the **STEREO** mode.
- 3 Press the **STATUS** button to clear the screen.

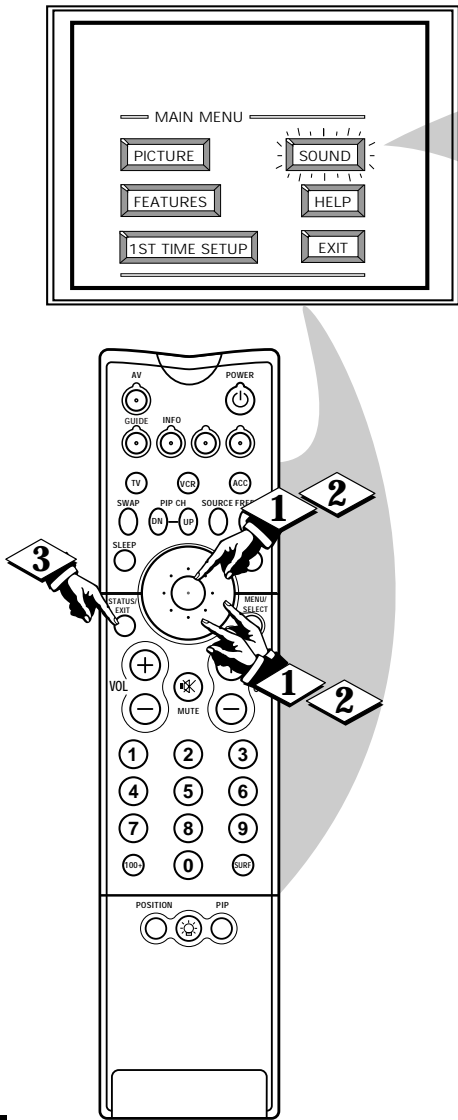

SMART HELP



Remember. If a stereo signal is not available and the TV is placed in the **STEREO** mode, sound coming from the TV will remain monaural (mono).

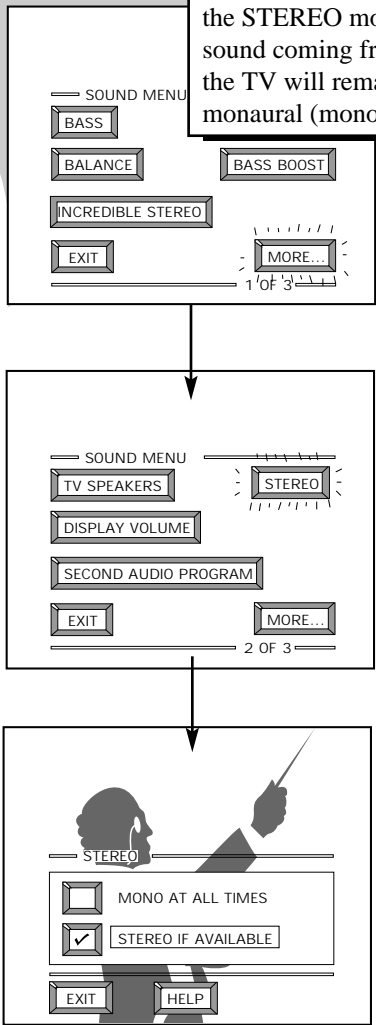

SECOND AUDIO PROGRAM

Second Audio Program (SAP) is part of the stereo broadcast system. Sent as an additional audio channel SAP can be heard apart from the current TV program sound. TV stations are free to use SAP for any number of purposes, but many experts believe it will be used for foreign language translations of TV shows (or for weather and news bulletins.)

NOTE: If a SAP signal is not present with a selected program, the SAP option can not be selected. "This program does not contain SAP information" will show on the TV screen.

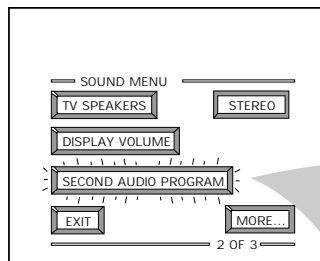

SECOND PROGRAM SOUND CAN ONLY BE SELECTED (✓) WHEN SAP INFORMATION IS PRESENT ON CURRENT CHANNEL.

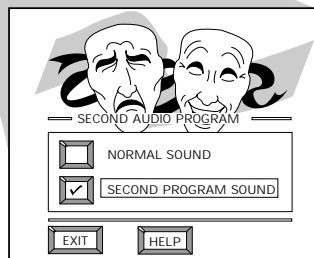

INCREDIBLE STEREO

The Incredible Stereo control can be used to add greater depth and dimension to both monaural (MONO) and STEREO TV sound.

BEGIN

- 1 Select the **INCREDIBLE STEREO** control.

With the **SOUND MENU** on the screen, move the **RED** highlight with the outer **MENU** ring buttons. Then press the center **MENU** button to select the feature.

- 2 Press the **MENU** ring and center **MENU** buttons to highlight and turn ON (↗) the **INCREDIBLE STEREO** mode.

For Example: "MAXIMUM" spreads the Incredible Stereo effect as wide as possible.

- 3 Press the **STATUS** button to clear the screen.

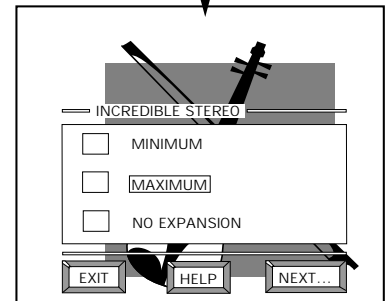
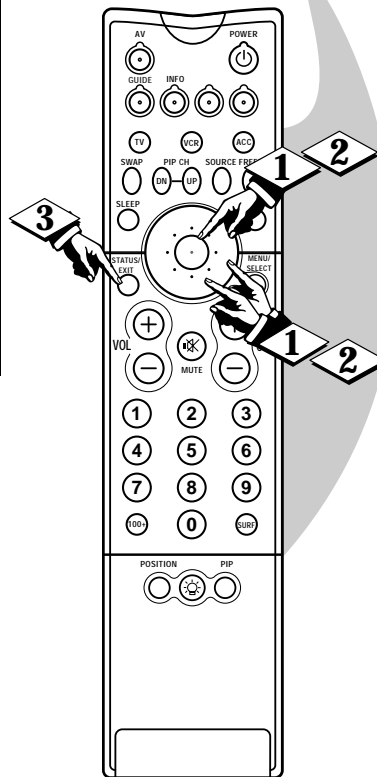
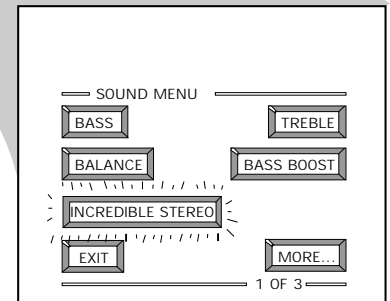
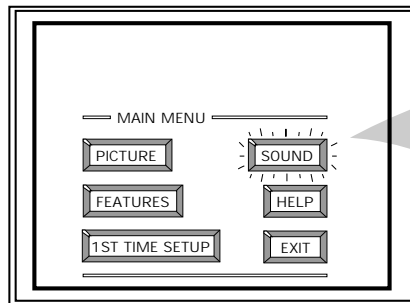

DISPLAY VOLUME

Use the **DISPLAY VOLUME** control to see the TV's volume level settings on the TV screen. Once set the Volume Display will be seen each time the **VOLUME** buttons (on the TV or remote) are pressed.

BEGIN

- 1 Select **DISPLAY VOLUME** control.

With **SOUND MENU** (2 of 3) on screen, move the **RED** highlight with the outer **MENU** ring buttons. Then press the center **MENU** button to select the feature.

- 2 Press the **MENU** ring and center **MENU** buttons to highlight and turn ON (✓) the **DURING ADJUSTMENT** Display Volume control.

- 3 Press the **STATUS** button to clear the screen.



SMART HELP

Remember, "**DURING ADJUSTMENT**" means the volume level will be on screen whenever the Volume buttons are pressed.

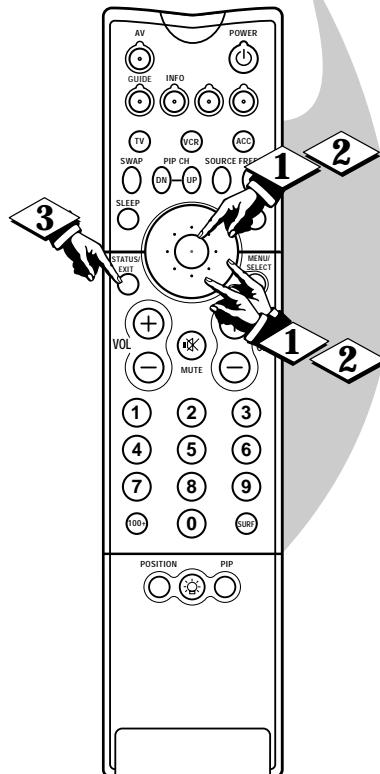
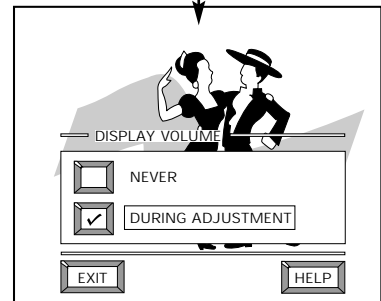
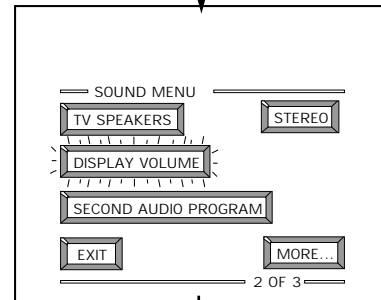
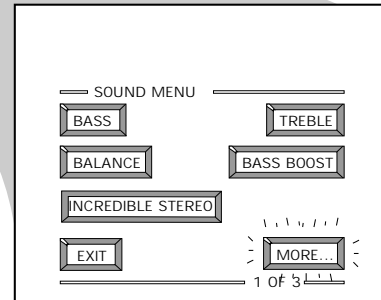
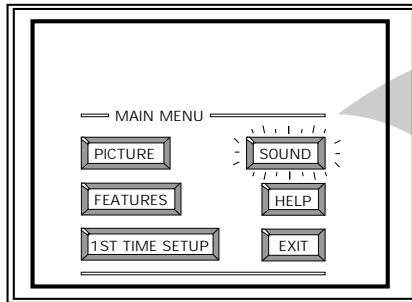

TV SPEAKERS

Would you like to hear TV programs through your audio hi-fi system? The TV's Variable Audio Output jacks and TV Speaker On/Off control work together to offer you this TV sound option.

BEGIN

- 1 Connect the R(ight) and L(eft) VARIABLE AUDIO OUT jacks on the TV to the R and L Audio Input jacks on your amplifier or sound system.

Set the audio system's volume to normal listening level.

- 2 Turn the TV and audio system ON. You can now adjust the sound level coming from the audio system with the Volume ▲▼ buttons on the TV or remote.

- 3 To hear the TV sound from only the audio system speakers, select TV SPEAKERS control.

With SOUND MENU (2 of 3) on screen, move the RED highlight with the outer MENU  ring buttons. Then press the center MENU button to select the feature.

- 4 Press the MENU ring and center MENU buttons to highlight and turn OFF (✓) the TV SPEAKERS control.

You should now only hear TV sound coming from the audio system speakers.

- 5 Press the STATUS button to clear the screen.



SMART HELP



Remember, the audio system may have to be in AUX(iliary) mode to play sound from the TV (Outputs).

Note: When the TV SPEAKER control is set to "NORMAL" (for TV speaker operation) make sure the VARIABLE AUDIO OUTPUT control (see next page) is also set to "STEREO" in order for the TV's AUDIO OUTPUT jacks to work properly.

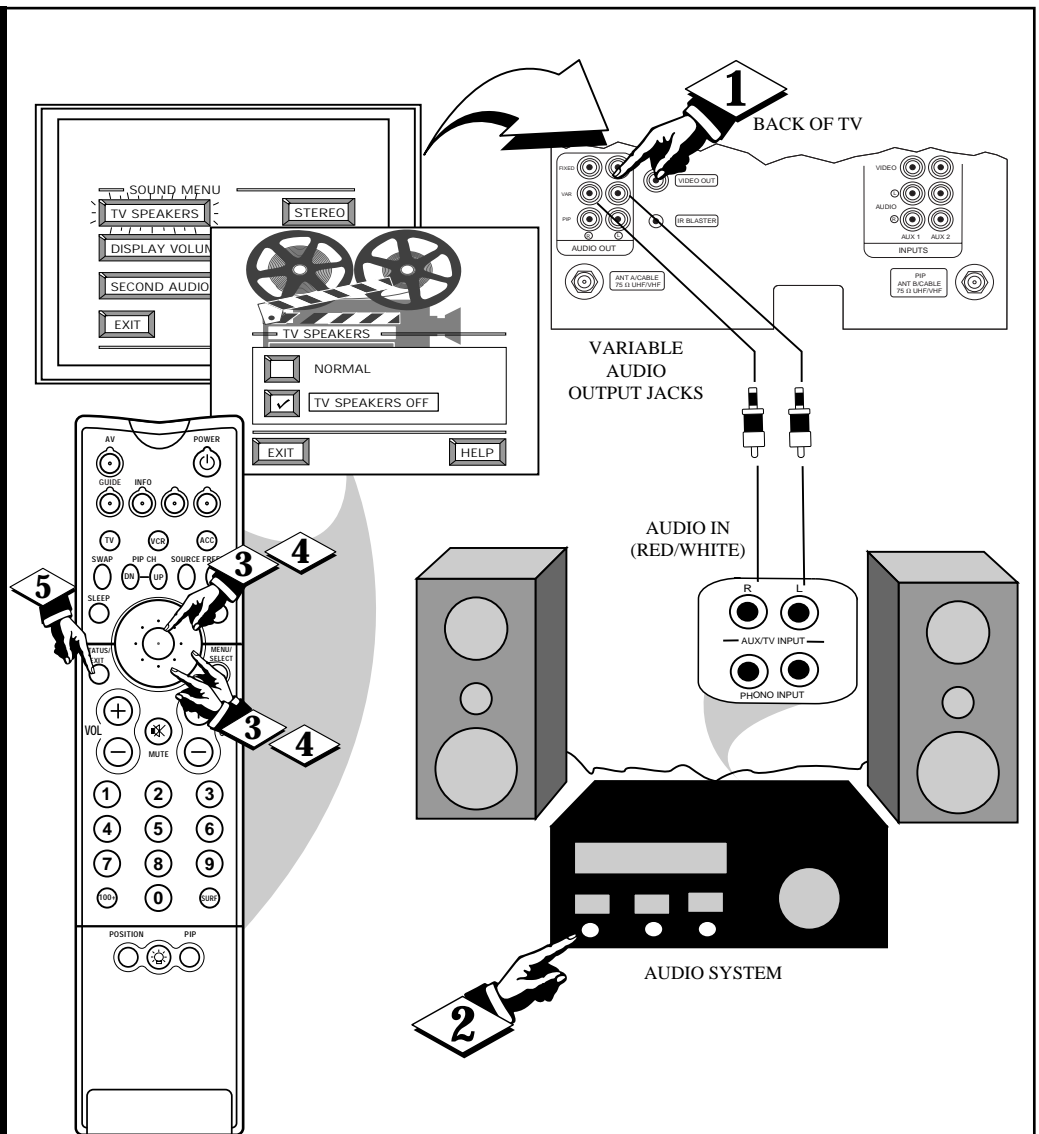

NOTE: The TV's FIXED AUDIO OUTPUT jacks can also be used for the playback of TV program sound with an external audio amplifier, or home theater hi-fi system. Connection of the FIXED AUDIO OUT(puts) is similar

to the Variable Audio Outputs (as shown above). However, specific sound level adjustments will be made with the controls at the external amplifier or home sound system (instead of through the TV's audio level controls.)

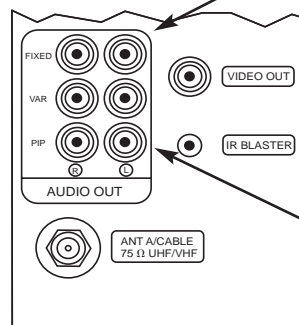

NOTE: The TV's PIP AUDIO OUTPUT jacks can also be used for additional stereo playback options such as wireless transmitter headphone hook-up, or as an external amplifier connection source. However, with normal PIP feature operations (when

the ANT A and ANT B Input sources are connected for use), the PIP AUDIO OUTPUTS will switch from stereo to monaural (mono) sound. Stereo sound will only be available with the TV's Main screen (or ANT A supplied signal) at that time.

SOUND MENU CONTROLS (CONTINUED)

SURROUND SOUND

By adding optional external speakers to the TV's sound system, you can create the feeling of reflected sound that surrounds you at a movie theater or concert hall.

BEGIN

- 1 **Connect both external speakers** to the speaker wire terminals on the TV.

Recommended speakers: 8ohm, 15 watt minimum. Be sure the (+) and (-) speaker wires are connected to the correct R(ight) and L(ef) speaker terminals on the TV.

- 2 **Place the speakers** so the viewing area is between the TV and the rear surround speakers. (See overhead view drawing.)

- 3 **Turn TV ON** and place the STEREO control to the "STEREO IF AVAILABLE" (✓) position.

After setup whenever a stereo signal is received the audio will be heard in Surround Sound.

STOP

REAR SURROUND SOUND SPEAKER TERMINALS

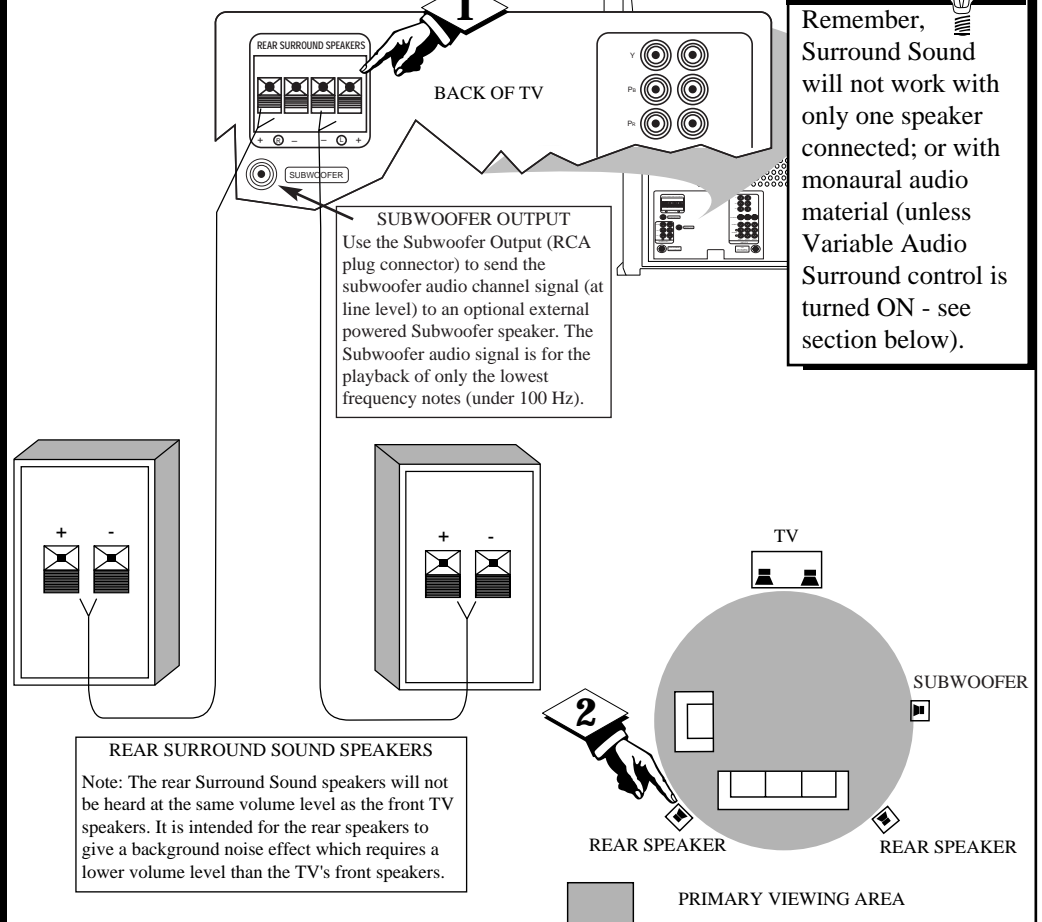

SMART HELP



Remember, Surround Sound will not work with only one speaker connected; or with monaural audio material (unless Variable Audio Surround control is turned ON - see section below).

VARIABLE AUDIO OUTPUT

The TV's Variable Audio Output jacks can also be used for Surround Sound. Once they are connected to an external hi-fi system its speakers can be used for the playback of Surround Sound.

BEGIN

- 1 **Connect the R(ight) and L(ef) VARIABLE AUDIO OUT** jacks on the TV to the R and L Audio Input jacks on your amplifier or sound system.

- 2 **Turn TV ON** and place the VARIABLE AUDIO OUTPUT on screen control to the SURROUND (✓) position. (Sound Menu 3 of 3).

Note: This will change the Left/Right channel audio line level signal at the Audio Output jacks to the same signal found at the TV's Surround Sound Speaker terminals.

STOP

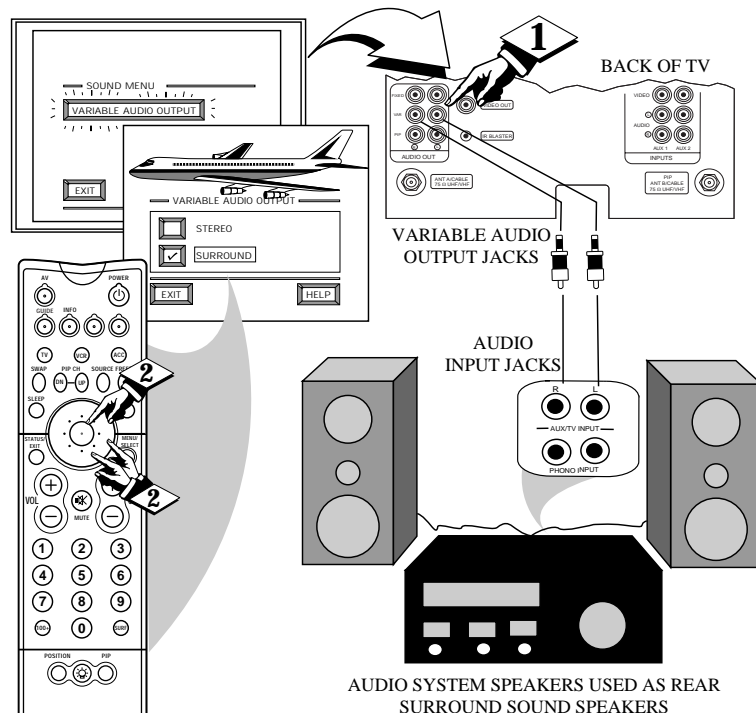

AUX 1 VIDEO INPUTS

The TV's Audio/Video Input jacks are for direct picture and sound connections between the TV and a VCR (or Video Disc Player, etc.) that has Audio/Video Output jacks.

To view the playback of a VCR tape by using the Audio/Video Input jacks on the TV:

BEGIN

- 1 Connect the VIDEO OUT jack from the VCR to the AUX 1 VIDEO IN jack on the TV.
- 2 Connect the AUDIO OUT jacks R(ight) and L(eft) from the VCR to the AUX 1 AUDIO IN jacks on the TV.
- 3 Select the "AUX 1 VIDEO" PICTURE SOURCE SELECT control on the TV.
With the FEATURES MENU on screen, move the RED highlight with the outer MENU ring buttons. Then press the center MENU button to select the feature.
- 4 Press the MENU ring and center MENU buttons to highlight and select (✓) the AUX 1 VIDEO mode.
- 5 Turn the VCR ON and press PLAY to view the tape on the TV.



SMART HELP



Remember, after it is connected an easy way to select the AUX 1 VIDEO mode is to press the AV button on the remote. Other Auxiliary modes (AUX 2 VIDEO, AUX 1 Y Pb Pr, etc.); ANT A/B, and the last channel viewed can also be selected by pressing the AV button.

Also, if you have added AUX 1 VIDEO to the TV's channel memory (see page 14), you can just press the CHANNEL ▲▼ buttons to select the AUX 1 mode.

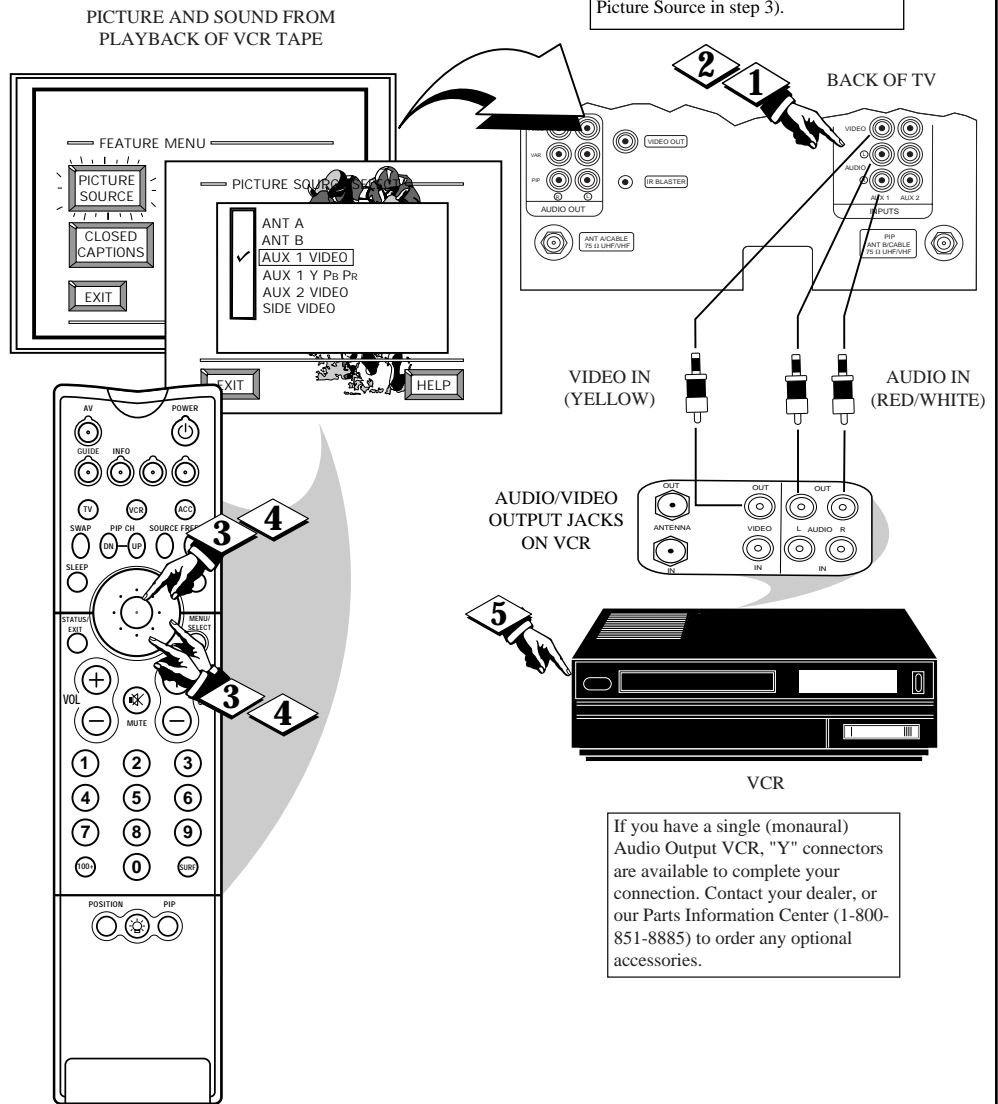

USING THE AUDIO/VIDEO INPUT JACKS (CONTINUED)

SIDE VIDEO INPUTS

For more convenient Direct playback connections the TV's Side Video Input panel can be used. Located on the TV's right side panel (angled toward the front for easy access) these Audio/Video Input jacks allow for quick connections, particularly for the playback of Camcorder tape recordings.

To view the playback of a Camcorder recording using the Audio/Video Input jacks on the side of the TV:

BEGIN

1 Connect the VIDEO OUT jack from the Camcorder to the VIDEO IN jack on the side of the TV.

2 Connect the AUDIO OUT jacks R(ight) and L(eft) from the Camcorder to the AUDIO IN jacks on the side of the TV.

3 Select the "SIDE VIDEO" PICTURE SOURCE SELECT control on the TV.

With the FEATURES MENU on screen, move the RED highlight with the outer MENU ring buttons. Then press the center MENU button to select the feature.

4 Press the MENU ring and center MENU buttons to highlight and select the SIDE VIDEO mode.

5 Turn the Camcorder ON and press PLAY to view the tape on the TV.



SMART HELP



Remember, an easy way to select the SIDE VIDEO mode is to press the AV button on the remote. Other Auxiliary modes, ANT A/B, and the last channel viewed can also be selected in this way.

Also, if you have added SIDE VIDEO to the TV's channel memory (see page 14), you can just press the CHANNEL ▲▼ buttons to select the SIDE VIDEO mode.

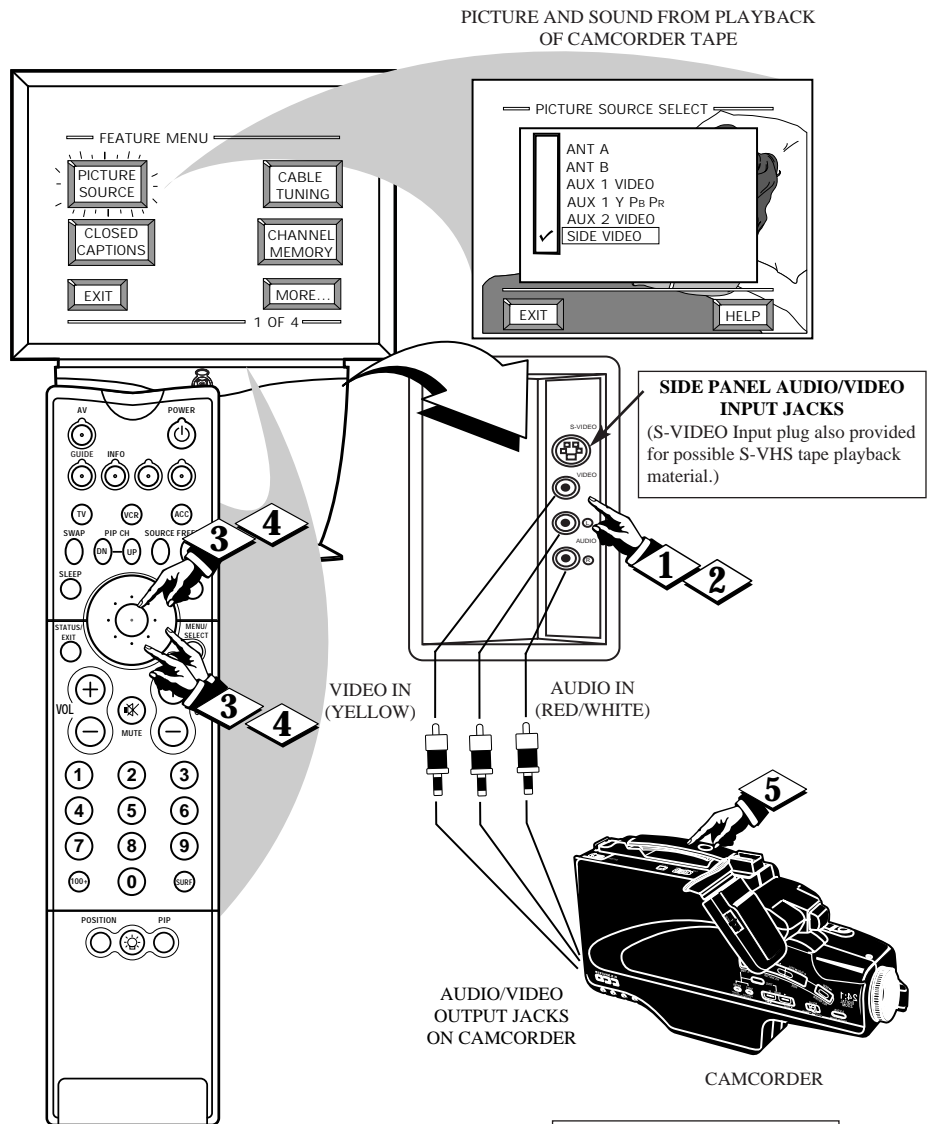

If you have a single (monaural) Audio Output Camcorder, "Y" connectors are available to complete your connection. Contact your dealer, or our Parts Information Center (1-800-851-8885) to order any optional accessories.

AUX1 - S-VIDEO INPUTS

The S(uper)-Video connection on the rear of the TV can give you better picture detail and clarity, for the playback of S-VHS VCR tapes or Video Discs, than the normal antenna picture connections.

Note: The VCR (or Video Disc Player) must have a S-VIDEO OUT(put) jack in order for you to complete the connections shown on this page.

BEGIN

- 1 Connect the S-VIDEO (S-VHS) OUT jack from the VCR to the S-VIDEO AUX 1 IN(put) jack on the TV.

The S-VIDEO connecting cable will be supplied with the S-VHS VCR (or Video Disc Player).

- 2 Connect the AUDIO OUT jacks R(ight) and L(ef) from the VCR to the AUDIO AUX 1IN(put) jacks on the TV.

- 3 Select the "AUX 1 S-VIDEO" PICTURE SOURCE control.

With the FEATURES MENU on screen, move the RED highlight with the outer MENU ring buttons. Then press the center MENU button to select the feature.

The "AUX 1 S VIDEO" picture source option appears only when a S-VIDEO cable has been connected to the TV's AUX 1 IN(puts).

- 4 Turn the VCR ON and place it in the S-VIDEO (or S-VHS) playback mode. Insert S-VHS cassette tape and playback in a normal manner.



SMART HELP



Remember, after it is connected an easy way to select the AUX 1 S-VIDEO mode is to press the AV button on the remote.)

Also, if you have added AUX 1 to the TV's channel memory, you can just press the CHANNEL ▲▼ buttons to select the S-VIDEO mode (when active).

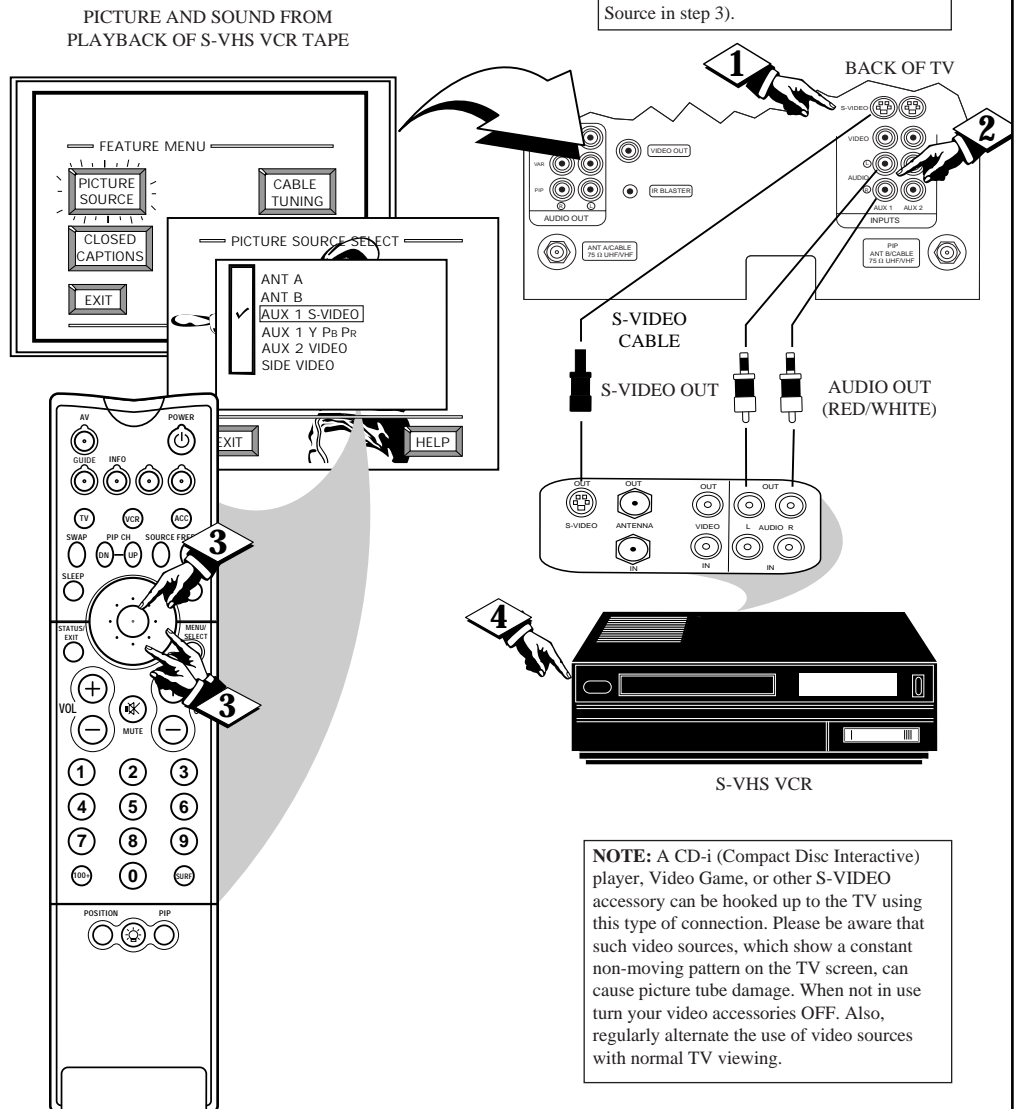

NOTE: A CD-i (Compact Disc Interactive) player, Video Game, or other S-VIDEO accessory can be hooked up to the TV using this type of connection. Please be aware that such video sources, which show a constant non-moving pattern on the TV screen, can cause picture tube damage. When not in use turn your video accessories OFF. Also, regularly alternate the use of video sources with normal TV viewing.

USING THE AUDIO/VIDEO INPUT JACKS (CONTINUED)

COMPONENT VIDEO INPUTS

Component Video Inputs provide for the highest possible color and picture resolution in the playback of digital signal source material such as with DVD players. The color difference signals (PB, PR) and the luminance (Y) signal are connected and received separately which permits for improved color bandwidth information (not possible when using composite video or S-Video connections).

BEGIN

1 Connect the Component (Y Pb Pr) VIDEO OUT jacks from the DVD player to the (Y Pb Pr) VIDEO IN(put) jacks on the TV.

2 Connect the AUDIO OUT jacks R(ight) and L(eft) from the DVD player to the AUX 1 AUDIO IN jacks on the TV.

3 Select the "AUX 1 Y Pb Pr" PICTURE SOURCE control on the TV.

With the FEATURES MENU on screen, move the RED highlight with the outer MENU ring buttons. Then press the center MENU button to select the feature.

4 Press the MENU ring and center MENU buttons to highlight and select (✓) the AUX 1 Y Pb Pr mode.

5 Turn the DVD player ON and press PLAY to view the source material playback on the TV.



PICTURE AND SOUND FROM PLAYBACK OF DVD SOURCE MATERIAL

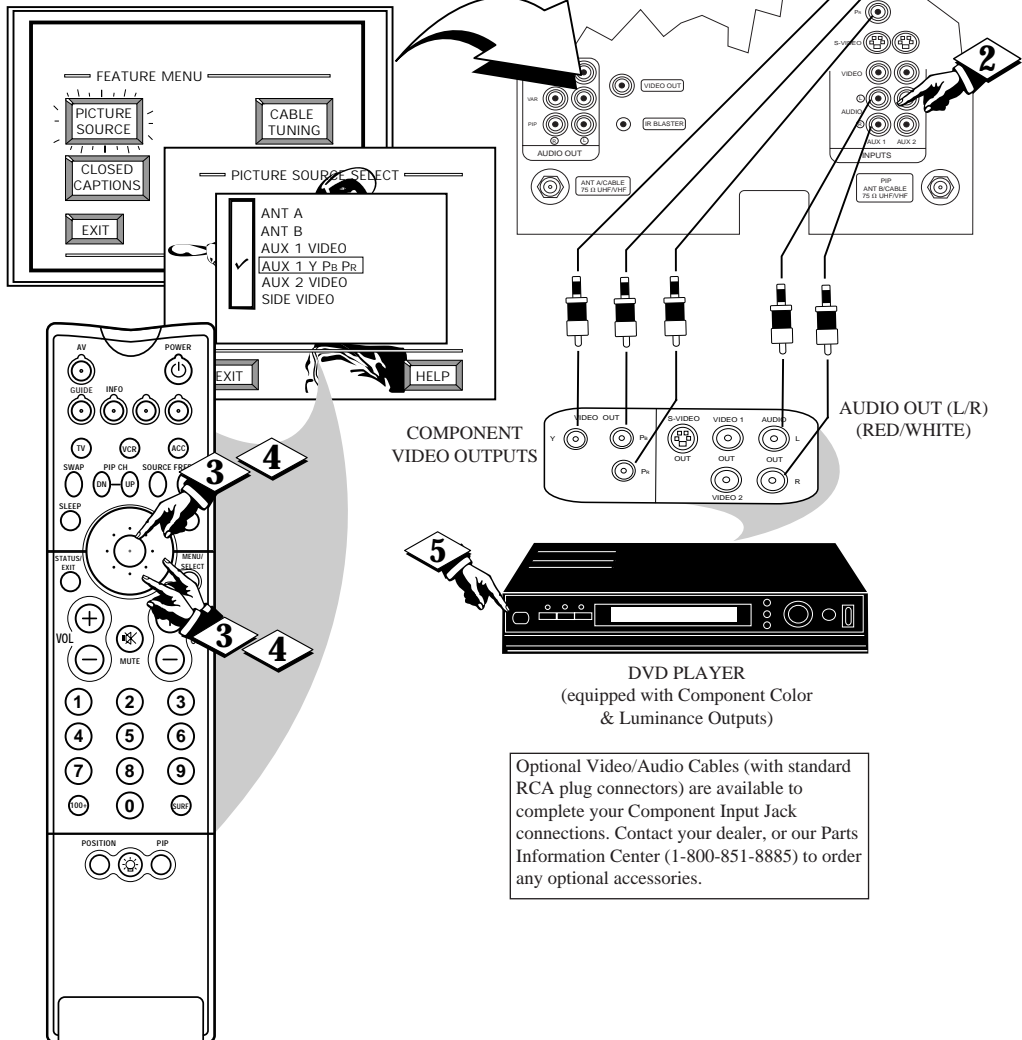

DVD PLAYER
(equipped with Component Color & Luminance Outputs)

Optional Video/Audio Cables (with standard RCA plug connectors) are available to complete your Component Input Jack connections. Contact your dealer, or our Parts Information Center (1-800-851-8885) to order any optional accessories.

SMART HELP



The description for the component video connectors may differ depending on the DVD player or accessory digital source equipment used (e.g. Y Pb Pr; R-Y/B-Y/Y; Cr/Cb/Y, etc.). Although abbreviations and terms may vary, the letters "B" and "R" stand for the blue and red color component signal connectors and "Y" indicates the luminance signal. Refer to your DVD or digital accessory Owner's Manual for definitions and connection details.



AUDIO/VIDEO OUTPUTS

The Audio/Video Output jacks on the TV can be used to record TV programs on VCRs which have Audio/Video Input jacks.

To record TV programs by using the Audio/Video jacks on the TV:

BEGIN

- 1 Connect the VIDEO OUT jack from the TV to the VIDEO IN jack on the VCR.
- 2 Connect the AUDIO OUT jacks R(ight) and L(eft) from the TV to the AUDIO IN jacks on the VCR.
- 3 Select the "ANTENNA A" PICTURE SOURCE control on the TV.
With the FEATURES MENU on screen, move the RED highlight with the outer MENU ring buttons. Then press the center MENU button to select the feature. Select the channel on the TV that you want to record.
- 4 Turn the VCR ON. Put a cassette tape in the unit and place the VCR in the RECORD mode.



SMART HELP



Remember, If the VCR has an INPUT SELECTOR switch, place it in the LINE or CAMERA position.

Unattended Timer Recordings with a VCR are possible, but not recommended with this connection since the TV must be left ON for the VCR to record.

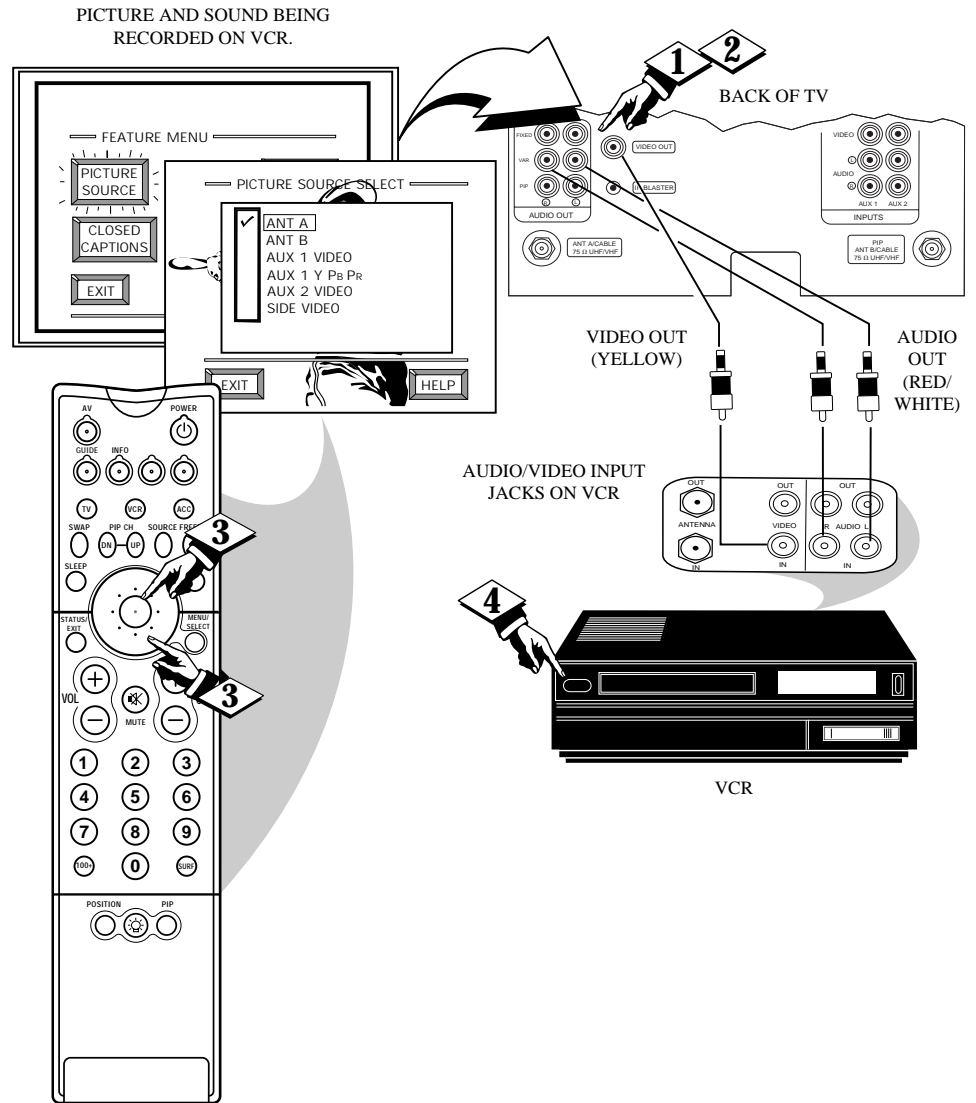

REMOTE CONTROL OPERATION

AUTO PICTURE

With Auto Picture you can set a number of video and audio controls to your own personal preference. Once the individual controls have been adjusted to the levels you desire, use the list of Auto Picture feature category titles to quickly reselect these “personalized” settings contained within the memory of the TV. (See the next page for more details on the labeling options and use of Auto Picture.)

BEGIN

- 1 Press the AUTO button** on the remote.
Press the center MENU button to select the Auto Picture feature (highlighted in RED).
- 2 Press the outer MENU ring (top and bottom) buttons** to highlight the category list for Auto Picture. Press the center MENU button to select (✓) the desired title.
- 3 Press the MENU ring** buttons to choose any of the individual controls you wish to adjust for the Auto Picture selected title. Then press the center Menu button to select the highlighted control.
- 4 Press the Menu ring and center Menu buttons** to adjust the selected control.
- 5 Press the STATUS button** on the remote to clear the screen after you have finished with all of your Auto Picture feature control adjustments.



SMART HELP

Note: Select the “FACTORY SETTINGS” category to automatically return the TV to the video and audio control levels preset at the factory prior to product shipment.

Note: For select models the AUTO PICTURE, AUTO SOUND, and AUTO SURF features may appear within the TV’s onscreen Menu as Smart Picture, Smart Sound, and Smart Surf. Use and operation of these functions will still be the same as described within the following sections.

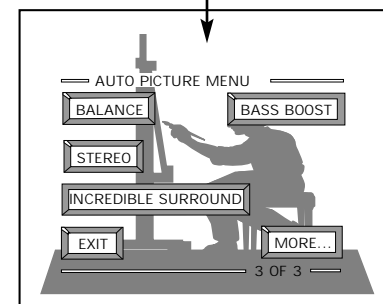
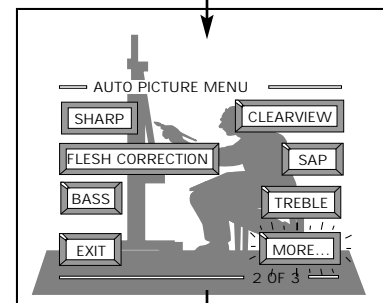
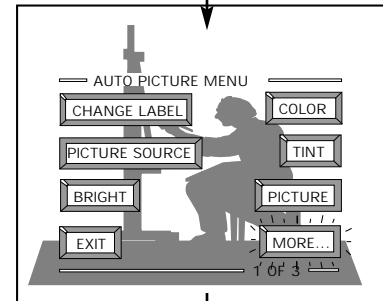
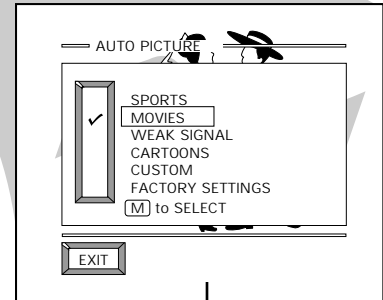
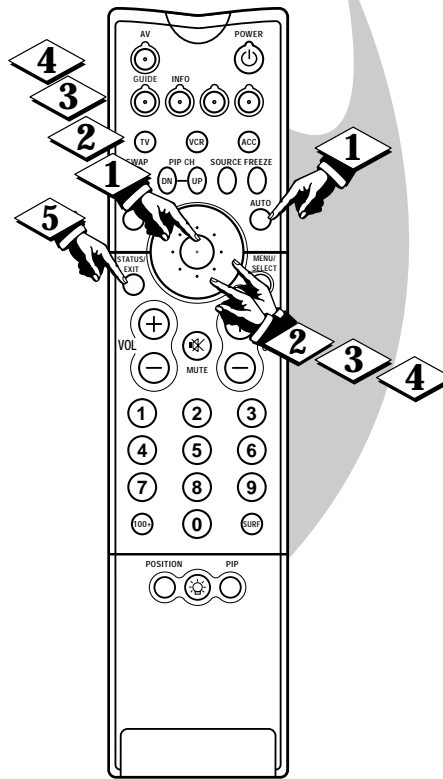
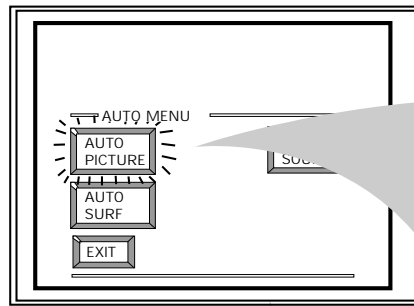



AUTO PICTURE

Following your initial setup adjustments (see previous page), just select the desired Auto Picture category in order to place the TV to the personalized set of audio and video control settings for that title.

BEGIN

- 1 Press the **AUTO** button on the remote.

Then press the MENU button to select the AUTO PICTURE control feature.

- 2 Press the outer MENU ring (top and bottom) buttons with the list of "AUTO PICTURE" categories on the TV screen to highlight the desired category. Then press the center Menu button to select the audio and video control settings for that particular title.

- 3 Press the **STATUS** button on the remote to clear the screen.

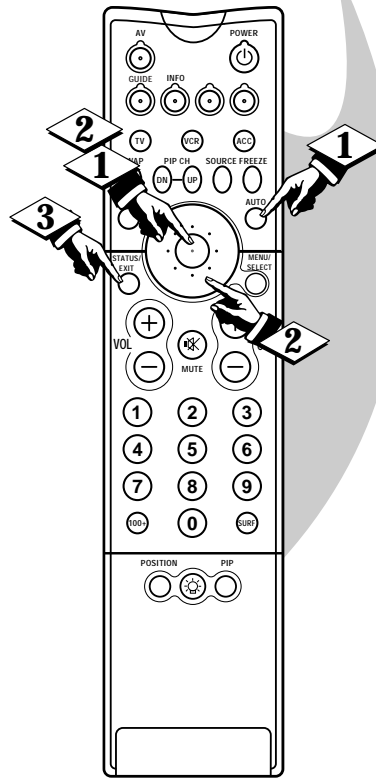
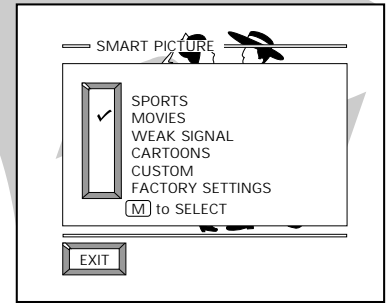
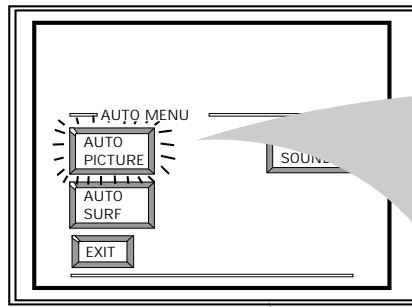

CHANGE LABEL

The "CHANGE LABEL" control can be used to change the title of a AUTO PICTURE setting into a name or label that may be easier for you to remember.

BEGIN

- 1 With the AUTO PICTURE "CHANGE LABEL" control on the screen, press the outer MENU ring (top and bottom) buttons to spell out a new label or title for the selected AUTO PICTURE category.

- 2 Press the outer MENU ring (left and right) buttons to move the red highlight to each letter space.

- 3 Press the **STATUS** button to clear the screen when the new label is finished.

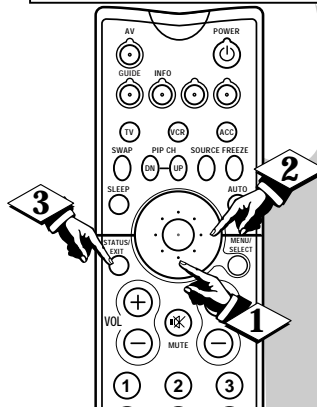
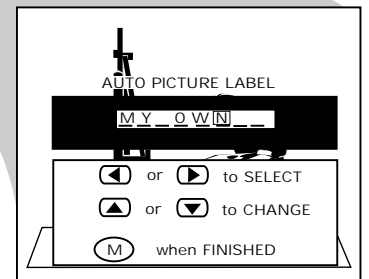
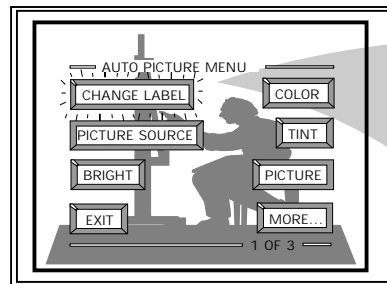

AUTO SOUND

Are you tired of the sound of commercials following you throughout the house? Auto Sound allows you to preset a desired volume level that the TV sound will not go above. This makes for an even, more consistent sound by reducing the “peaks” and “valleys” that can occur during commercials.

BEGIN

- 1 Press the **AUTO** button on the remote.
- 2 With the **AUTO** Menu on screen, move the RED highlight with the outer **MENU** ring buttons. Then press the center **MENU** button to select the highlighted Auto Sound control.
- 3 Press the **Menu** ring and the center **Menu** buttons to turn the Auto Sound control ON (or OFF.)
- 4 Press the **STATUS** button to clear the screen when completed.



SMART HELP



Remember, Auto Sound works for sound levels coming from either the Antenna/Cable input on the rear of the TV (RF audio); or the Auxiliary (VCR/AUX IN) audio inputs.

When using a Cable Converter Box with the Auto Sound Control ON, the TV's volume level may take up to ten seconds to gradually increase to normal listening levels (when the TV's first turned on). This is considered NORMAL with various Cable Converter Box use.

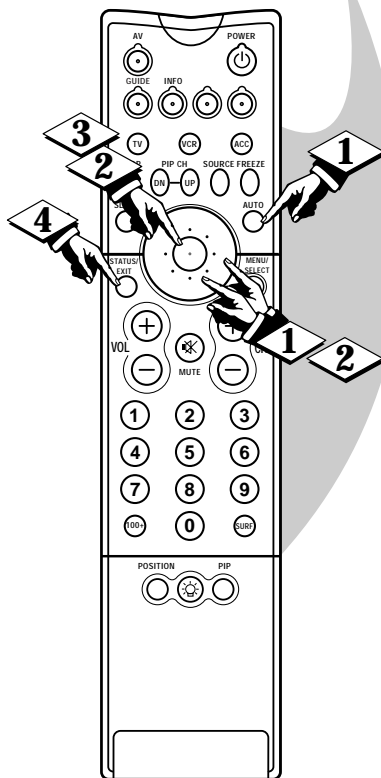
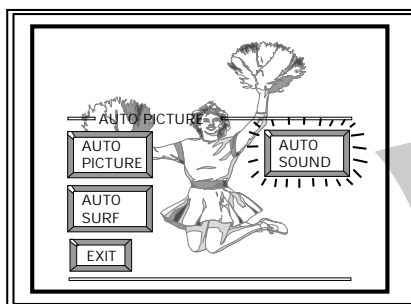

Note: For select models the AUTO PICTURE, AUTO SOUND, and AUTO SURF features may appear within the TV's onscreen Menu as Smart Picture, Smart Sound, and Smart Surf. Use and operation of these functions will still be the same as described within the following sections.





2-CHANNEL SURF/AUTO SURF

A "list" or series of previously viewed channels can be selected with the SURF button on your remote control. With this feature you can easily switch between different TV programs that currently interest you. The Auto Surf control allows you to set up to 10 channels in its quick viewing "list".

BEGIN

- 1 Press the **AUTO** button on the remote.
- 2 With the **AUTO** Menu on screen, move the **RED** highlight with the outer **MENU** ring buttons. Then press the center **MENU** button to select the highlighted Auto Surf control.
- 3 Press the **Menu** ring then the center **Menu** button to select either Auto Surf or 2-Channel Surf. (See explanation of Surf options with the illustration on this page.)
- 4 Press **STATUS** button on the remote control to clear the screen.

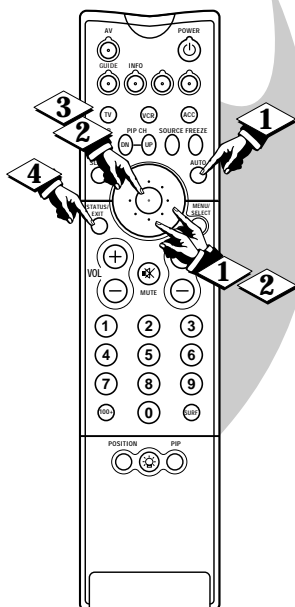
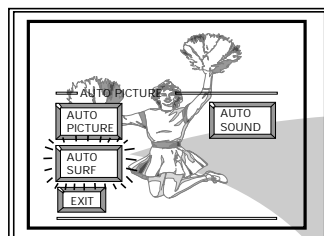

2 CHANNEL SURF- Current and one previous channel in the ring.

AUTO SURF - Current and up to nine additional channels available in the ring. Note: The Channel Surf ring can be used with fewer than ten channels. In this way, the number of Surf channels can match or fit your present viewing interests.

SMART HELP



To Use 2-Channel Surf:
With the **2-Channel Surf** control **ON**, select the two desired channels for viewing with the number buttons on the remote control. Then press the **SURF** button on the remote to "toggle" between the two selected channels.

HOW TO USE AUTO SURF

BEGIN

- 1 With the **Auto Surf** control **ON** (see above), select a desired **channel** for viewing. You can use the number buttons on the remote (or the Channel **▲▼** buttons).
- 2 Press the **SURF** button on the remote. (Some channel numbers may already appear within the Surf channel list.)
- 3 Press the center **Menu** button to "ADD" the selected channel to the Surf list.
Select the next desired channel and repeat steps 2 and 3. Continue until all desired channels are on the Surf list.
- 4 Press the **SURF** button on the remote to quickly review current action on channels contained within the Surf list.

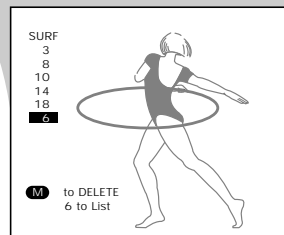
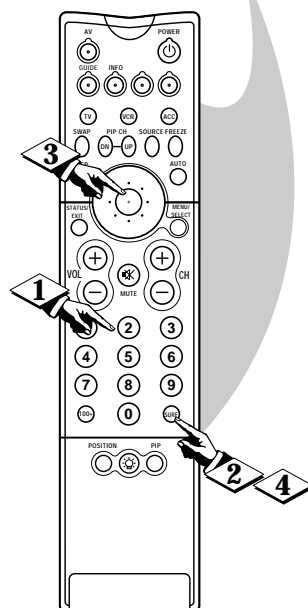
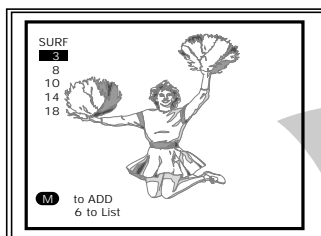

Note: To Delete a channel from the Surf list just press the **SURF** button to select the desired channel. Then press the **Menu** button and the channel will be immediately dropped from the on-screen Surf list.

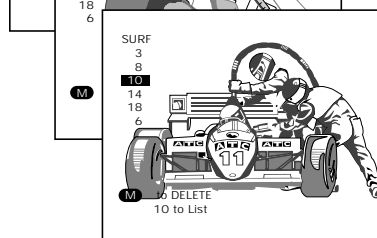
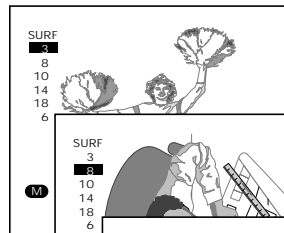

SETTING THE TV REMOTE TO WORK ACCESSORY DEVICES

Your remote control is set to work your TV and many infrared remote (IR) control VCRs, Cable TV Converter Boxes, DVD players, Home Satellite receivers, etc. However, an easy one-time step may be necessary before the remote will work with your accessory device.

To begin, try this initial check to see if going on to the following section is necessary.

BEGIN

- 1 Press the **VCR** or **ACC(essory) System** button on the TV remote for the desired accessory device category.

Note: The ACC(essory) system button contains product codes for Cable TV Converters, DVD players, and Satellite receivers.

- 2 Point the TV remote toward the desired accessory device and press the POWER button.

- 3 Does the remote turn the accessory device ON?
IF YES, **STOP** and try other function buttons on the TV remote. If they also work the accessory device, then the remote is ready and no further steps are needed.

IF NO, continue...

- 1 First look up a **THREE-DIGIT remote code number** for your brand of Accessory Device before going through the simple Direct Access Method steps shown on the following page.

Find your Three Digit Code Number on pages 45-46.

SMART HELP



Remember, if more than one number is listed, you may have to try more than the first three-digit code given in order to locate your device's correct code.

TV REMOTE VCR/ACCESSORY SYSTEM BUTTONS

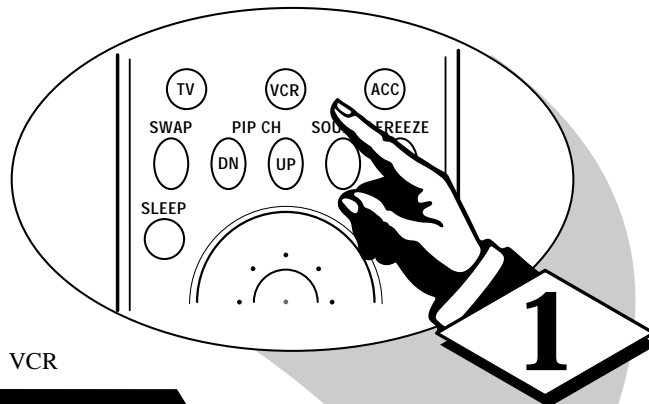

VCR

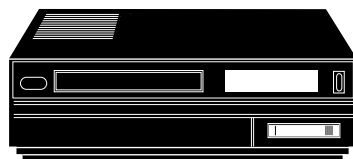

SATELLITE
RECEIVER



CABLE CONVERTER

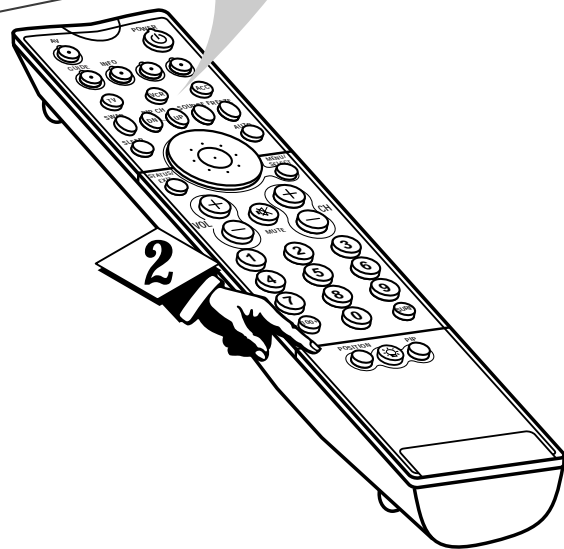

SETTING THE TV REMOTE TO WORK ACCESSORY DEVICES



DIRECT ACCESS METHOD

Now that you have looked up the three-digit Remote Code Number for your brand of accessory device (see page 45-46), you are ready to follow the simple steps shown below.

Please read through all the steps before beginning.

(BEGIN)

- 1 Press and release the correct **VCR or ACC(essory) System** button.
- 2 Press and release the center **Menu** button.
- 3 Within **thirty seconds** after releasing the center Menu button, **ENTER THE THREE DIGIT CODE NUMBER** for the desired device. The remote is now ready to send commands to the accessory.
- 4 **Point the remote** at the accessory device. Press the **POWER** button on the remote to turn the device ON.



SMART HELP



Remember, if this does not work the first time, repeat steps using the same remote code number.

If after a second try the remote does not operate your accessory device, and there are more code numbers listed for your brand, use the next listed code number.

If after repeated attempts the code number method does not work your accessory device, try the "SEARCH METHOD" shown on the following page.

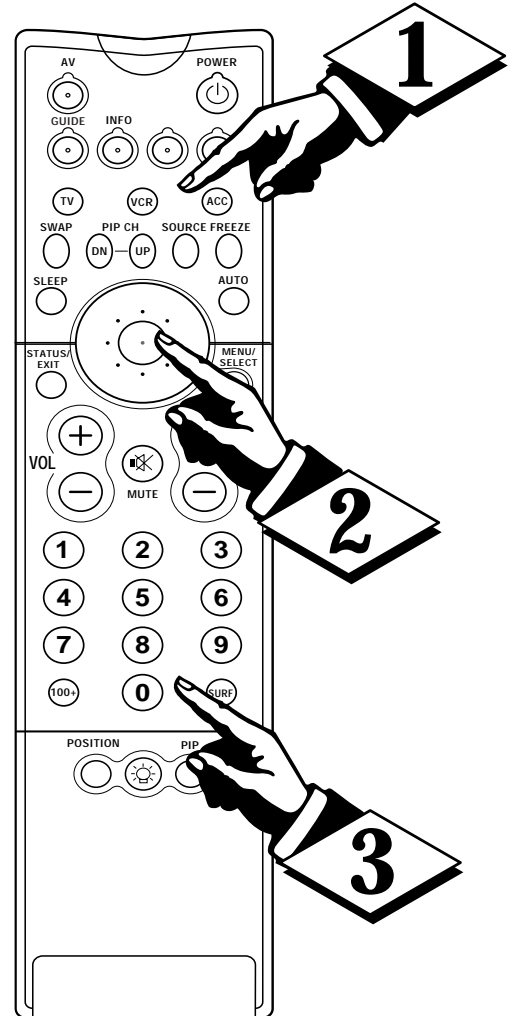
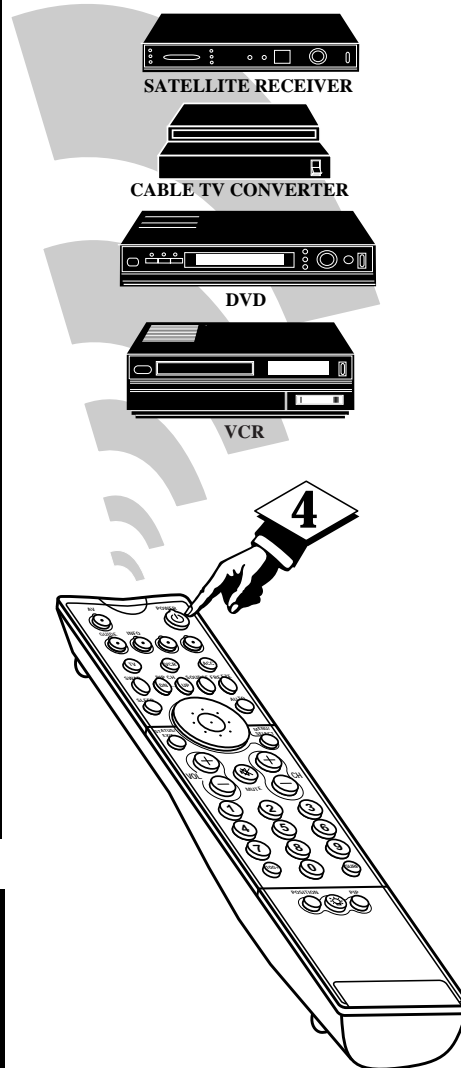

Note: For TV remote's equipped with a backlight option, the unit may "blink" or flash as the three-digit Direct Access code numbers are entered on the keypad. (Two blinks indicate a valid code number entry has been accepted; one long blink indicates an invalid code number or the thirty second time interval for entering code numbers has expired.)



SETTING THE REMOTE TO WORK OTHER DEVICES - SEARCH

SEARCH METHOD

Your TV remote can be set to work various accessory devices (VCRs, Cable Converters, Satellite Receivers) by what is called the SEARCH method.

Note: The Search Method only works with devices equipped with Channel Display Indicators or capability. If the "Direct Access" code number method (shown in the previous section) did not set your remote to work your accessory device, then follow the easy steps listed below.

BEGIN

- 1** Turn ON the desired device. Press the correct VCR or ACC system button on the remote.
- 2** Stand at least six feet away from the front of the accessory device. Point the remote toward the unit. HOLD DOWN the SURF and the desired System (VCR or ACC) buttons at the same time. KEEP HOLDING BUTTONS DOWN.
- 3** Watch the Channel Indicator on the unit. Channel Numbers will SCAN UP when the unit has been identified. This may take up to two minutes.
- 4** Release the SURF and System (VCR or ACC) buttons as soon as channel numbers start to scan up. The code has been identified and the remote is ready to operate with the accessory device.



SMART HELP



Remember, a minute or two can seem very long, but the code should be located within two minutes.

Don't let the accessory device scan up more than five channels. The remote may pass up the right code and another two minute search cycle will have to be repeated.

If no channel change happens within two minutes, repeat steps 1-4. Should a channel change still not occur, the remote will not work with the desired unit.

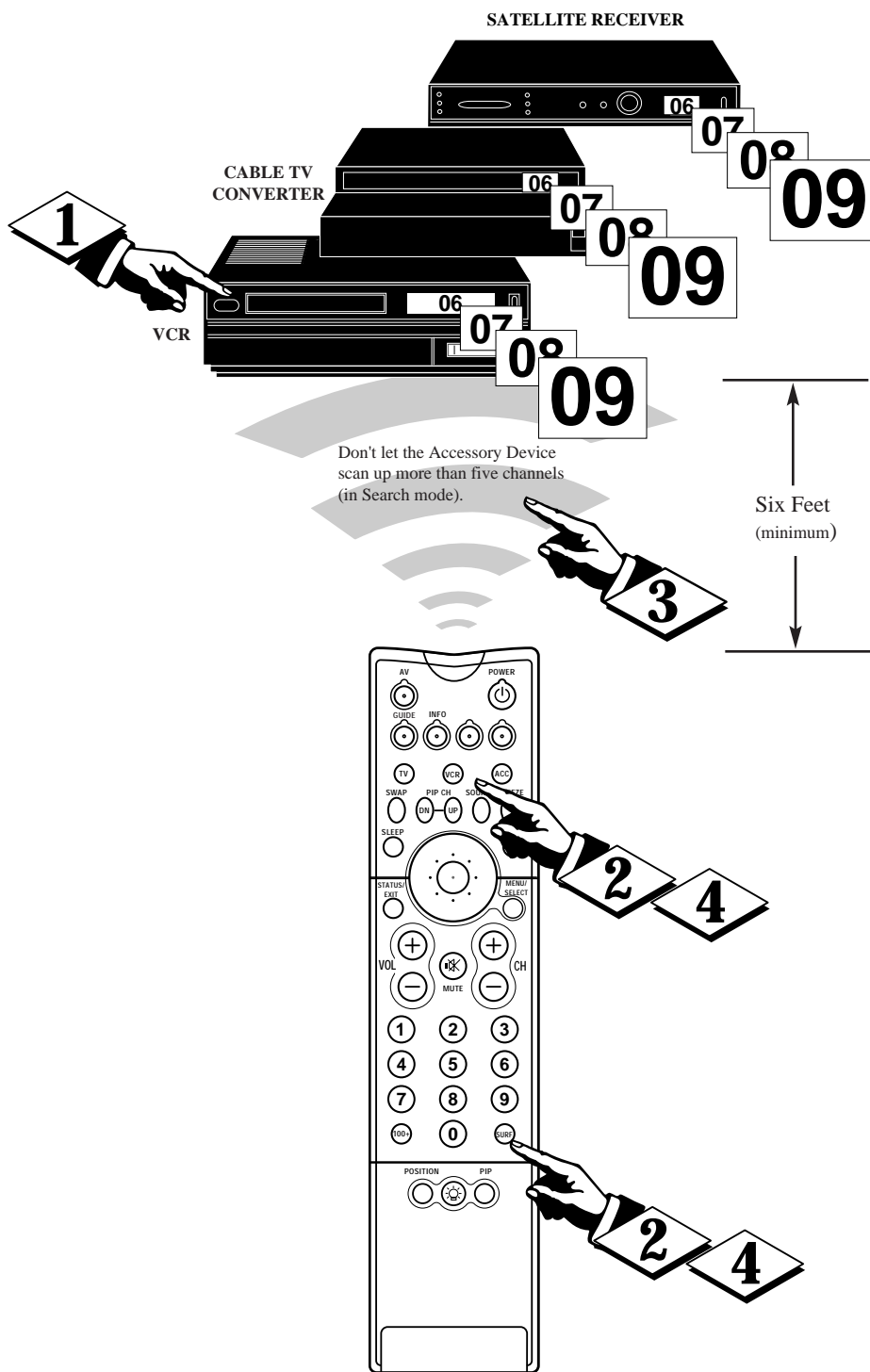

Note: For TV remote's equipped with a backlight option, the unit may "blink" or flash as the remote moves through its product code list. Once a product code has been identified and the buttons on the remote are released, the unit will blink twice.

REMOTE CONTROL DIRECT ENTRY CODES FOR ACCESSORY DEVICES



<u>VCR BRAND</u>	<u>REMOTE CODE NO.</u>	<u>VCR BRAND</u>	<u>REMOTE CODE NO.</u>	<u>VCR BRAND</u>	<u>REMOTE CODE NO.</u>
Admiral	075	Lloyd's	027, 235	Runco	066
Adventura	027	Logik	099	STS	069
Aiko	305	MEI	062	Salora	102
Aiwa	334, 495, 027, 064	MGA	070, 088, 267	Samsung	267, 072, 080, 078
Akai	133, 080, 076, 088, 183, 269, 068	MGN Technology	267	Sanky	066, 075
American High	062	MTC	027, 267	Sansui	506, 068, 109, 298, 027, 094
Asha	267	Magnasonic	305	Sanyo	073, 074, 131, 267
Audiovox	064	Magnavox	062, 108, 137, 130, 027, 066, 176	Scott	211, 148, 238, 072, 237, 239, 070
Beaumont	267	Magnin	267	Sears	069, 132, 081, 073, 064, 074, 131, 027, 062, 093
Bell & Howell	131	Marantz	108, 065, 062	Semp	072
Broksonic	211, 148, 388, 029, 236, 238, 322, 506	Marta	064	Sharp	075, 089
CCE	099, 305	Matsushita	062, 481, 189	Shintom	099
Calix	064	Memorex	131, 074, 027, 064, 062, 075, 267, 334, 073, 066, 828, 829	Shogun	078, 267
Canon	194, 062, 129	Minolta	132, 069	Signature	062
Capehart	047	Mitsubishi	070, 088, 200, 241, 102, 269, 094, 470, 075	Singer	099
Carver	108	Motorola	062, 075	Sony	060, 061, 059, 280, 038, 062, 027
Cineral	305	Multitech	027, 099	Sunpak	280
Citizen	305, 064	NAD	085	Sylvania	062, 108, 027, 130, 137, 070
Colt	099	NAP	060, 061, 062, 064, 066, 069, 093, 132	Symphonic	027
Craig	064, 074, 099, 267, 298	NEC	065, 067, 068, 077, 094, 109, 131	TMK	063, 235, 267
Curtis Mathes	062, 068, 087, 189	Nikko	064	Tatung	068
Cybernex	078, 267	Nikon	061, 280	Teac	027, 068
Daewoo	305, 588, 047, 072	Noblex	267	Technics	062, 189, 273, 066, 087, 229, 254
Daytron	047	Olympus	062, 253	Teknika	027, 062, 079, 064
Denon	069	Optimus	827, 828, 085, 829, 075, 064, 459, 131, 189, 481	Thomas	027
Dynatech	027	Optonica	089	Toshiba	072, 239, 237, 093, 393, 070
Electrohome	064	Orion	506, 322, 029, 211	Totevision	064, 267
Electrophonic	064	Panasonic	062, 828, 253, 104, 189, 405, 129, 252, 254, 273, 481	Unitech	267
Emerex	059	Penney	062, 267, 064, 065, 069, 067, 081	Vector	072
Emerson	211, 029, 148, 236, 063, 238, 305, 321, 115, 235, 506, 088, 239, 588, 095, 322, 388, 537, 027, 064, 070	Pentax	092, 069, 132	Vector Research	065, 067
Fisher	074, 131, 081, 093	Philco	062, 506, 236	Video Concepts	067, 088, 248, 072
Fuji	060, 062	Philips	108, 062, 089, 137, 803, 804	Videosonic	267
Funai	027	Pilot	064	Wards	062, 075, 089, 027, 087, 074, 072, 267, 239, 069, 099, 176, 108
GE	062, 087, 092, 229, 075, 267	Pioneer	085, 195, 094	White Westinghouse	305
Garrard	027	Portland	047	XR-1000	099, 027, 062
Go Video	306, 259, 459, 553	Profitronic	267	Yamaha	065, 068
GoldStar	064, 045, 065, 498, 507	Proscan	087, 229	Zenith	066, 060, 061, 027, 506
Gradiente	035, 027, 435	Protec	099		
Grundig	222	Pulsar	066, 078		
HI-Q	074	Quarter	073		
Harley Davidson	027	Quartz	073		
Harman/Kardon	108, 065, 102	Quasar	062, 189, 104, 481, 828		
Harwood	095, 099	RCA	087, 176, 229, 069, 132, 092, 104, 133, 304, 062, 075, 267		
Headquarter	073	Radio Shack	027		
Hitachi	069, 193, 132, 092, 423, 027, 068, 109	Radix	064		
JVC	094, 035, 233, 234, 068, 411	Randex	064		
Jensen	068, 102	Realistic	074, 027, 131, 075, 064, 062, 089, 073, 093		
KEC	064, 305	Ricoh	061, 280		
KLH	099				
Kenwood	411, 068, 094, 065, 073				
Kodak	062, 064				
LXI	064				

Continued on Next Page



REMOTE CONTROL DIRECT ENTRY CODES FOR ACCESSORY DEVICES

CABLE CONVERTER REMOTE CODE NO.

ABC	.030, 035, 038, 040, 028, 034, .041, 044
Allegro	.180, 342
Antronix	.049, 234
Archer	.049, 180, 234, 824
BBT	.294
Belcor	.083
Bell & Howell	.041
Cable Star	.083
Cabletenna	.049
Cableview	.049
Century	.180
Citizen	.180, 342
Colour Voice	.052, 058
Comtronics	.067
Contec	.046
Digi	.664
Eastern	.029
Emerson	.824
Everquest	.042, 067
Focus	.427
GC Electronics	.083, 234
Garrard	.180
Gemini	.042
General Instrument	.303, 503, 038, 837
GoldStar	.067, 171
Goodmind	.824
Hamlin	.047, 036, 286, 061
Hitachi	.038
Hytex	.034
Jasco	.042, 180, 342
Jerrold	.030, 039, 303, 038, 041, 042, .051, 503, 837
Linsay	.467
Magnavox	.054, 041
Memorex	.027
Movie Time	.090, 183
NAP	.034
NSC	.183, 090
Novaplex	.645
Oak	.046, 034
Optimus	.048
Panasonic	.048, 134, 027
Panther	.664
Paragon	.027
Philips	.052, 058, 054, 180
Pioneer	.171, 050, 560
Popular Mechanics	.427
Proscan	.048
Pulsar	.027
Quasar	.027
RCA	.048
Radio Shack	.824, 042, 342, 847
Realistic	.234
Recoton	.427
Regal	.286, 047
Regency	.029
Rembrandt	.038
Runco	.027

CABLE CONVERTER REMOTE CODE NO.

SL Marx	.067
Samsung	.067, 171
Scientific Atlanta	.035, 044, 504
Seam	.537
Signal	.042, 067
Signature	.038
Sprucer	.048
Starcom	.030, 042
Stargate	.067, 042, 824
Starquest	.042
Sylvania	.028
TFC	.337
TV86	.090
Tandy	.285
TeleCaption	.248
Televue	.067
Texscan	.028
Timeless	.445
Tocom	.039, 040
Toshiba	.027
Tusa	.042
Unika	.234, 180, 049
United Artists	.034
Universal	.234, 049, 083, 218, 180
Viewstar	.285, 054, 090
Zenith	.027, 552, 081, 035, 042, 234
Zentek	.427

SATELLITE RECEIVER REMOTE CODE NO.

AlphaStar	.799
Amplica	.099
Amway	.102
Astro Industries	.122
BSR	.122
Capetronic	.122
Channel Maste	.045, 239
Chaparral	.080, 236, 243
Curtis Mathes	.088, 099
DX Antenna	.068
Drake	.091, 272, 045, 176
Echostar	.307, 802, 175, 186, 296
Expressvu	.802
General Instrument	.388, 896, 654
HTS	.802
Hitachi	.846
Homecable	.265
Hughes Network Systems	.776
Hytex	.122
IQ	.237
IQ Prism	.237
JVC	.802
Janeil	.179
Jerrold	.388, 654
Legend	.296
Macom	.088, 045
Magnavox	.749, 751
Memorex	.296, 751
Next Level	.896
Panasonic	.179, 728

SATELLITE RECEIVER REMOTE CODE NO.

Philips	.227, 749, 751
Pico	.102
President	.101
Primestar	.654, 388
Proscan	.593
RCA	.593, 170, 882
Radio Shack	.593
Ramsey	.102
Realistic	.079
STS	.237, 068
Sony	.666
Star Choice	.896
Star Trak	.207
Toshiba	.109, 817, 088
Uniden	.265, 397, 079, 101, 751, 103, 749
Zenith	.091, 088, 883, 272

DVD BRAND REMOTE CODE NO.

Harman/Kardon	.871
JVC	.868
Kenwood	.865
Magnavox	.860
Mitsubishi	.861
Onkyo	.860
Optimus	.863
Panasonic	.859
Philips	.866, 860
Pioneer	.863, 869
Proscan	.862
RCA	.862
Samsung	.870
Sony	.864
Technics	.859
Toshiba	.860
Yamaha	.867, 859
Zenith	.872, 860

LASER DISC REMOTE CODE NO.

Aiwa	.855
Carver	.853, 850, 858
Denon	.851, 849
Disco Vision	.848
Funai	.855
Harman/Kardon	.853
Hitachi	.848
Magnavox	.853, 857
Marantz	.853, 850
Mitsubishi	.849
NAD	.849
Panasonic	.856
Philips	.853, 850
Pioneer	.849, 848
Quasar	.856
Realistic	.855
Sam	.848
Sony	.854, 852
Technics	.856
Theta Digital	.853
Yamaha	.857



When using the TV remote with a VCR, first make certain it is set to control your VCR (by the REMOTE CODE or SEARCH method - see earlier sections).

BEGIN

- 1 Press the VCR System button on the remote.
- 2 Point the top of the remote toward the front of the VCR (remote sensor window) when pressing buttons.



TV-VCR (AV) Button

Press to the VCR position ("VCR" indicator on the VCR will light) to view the playback of a tape. Press again to place in the TV position ("VCR" indicator on the VCR will go OFF) to view one program while recording another program. When used with the television the AV button works as a source button. Each press cycles the TV between the AUX(iliary) Input modes, ANT A/B inputs, and the the last view channel. It is a quick one-button way to select these channels and modes (without directly entering the TV's Menu system.)

Status/Exit Button

Press to clear the screen of menu controls or display a feature operation status screen.

Record/VCR Plus+ Button

Press the RECORD button to start a recording (with some VCR models you may also need to press the PLAY button on the remote to begin recording). Also use this button to set timer recordings with the VCR Plus+ programming system.

Clear Button

Press to erase incorrect entries or data when programming VCR functions.

Rewind Button

Press to rewind tapes. For some VCRs you may need to press STOP button first then REWIND. In playback mode, hold button down to view picture moving rapidly in reverse.

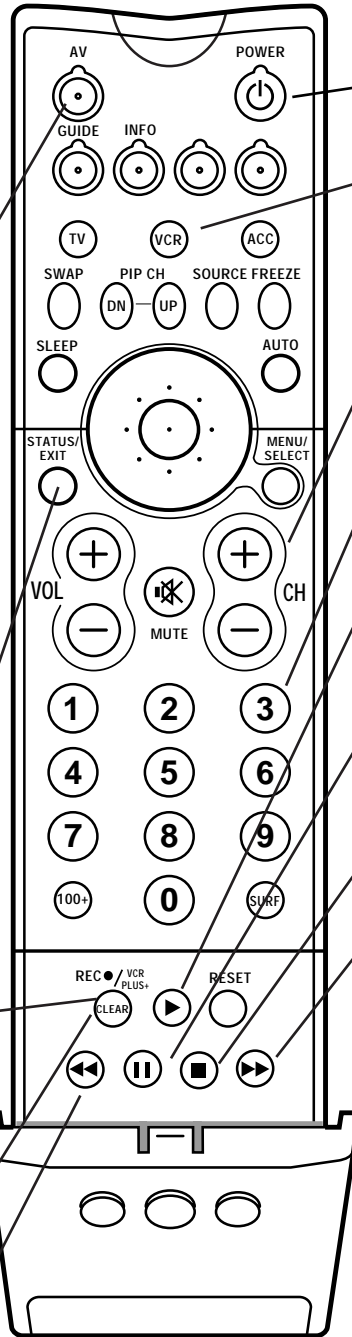

Open the remote control VCR button compartment with the pull tabs located on both sides of the hinged door or lid.

Power Button

Press to turn the VCR ON and OFF.

VCR System Button

Press to send remote commands to the VCR.

Channel Scan Buttons

Press to scan up or down through VCR channel numbers.

Number Buttons

Press buttons for direct VCR channel selections.

Play Button

Press to playback a tape. Hold down after pressing the RECORD button to start a recording.

Pause Button

Press to temporarily stop the tape during a playback, or recording. Press again to release Pause.

Stop Button

Press to stop the tape.

Fast Forward Button

Press to rapidly advance the tape. For some VCRs you may need to press STOP first then FF. In Playback mode hold button down to view the picture moving rapidly in the forward direction.

SMART HELP



Remember, the VCR buttons on the remote will not operate your VCR if those features are not already found on your VCR remote control.

Note: All VCR functions (particularly Search, Rewind, Fast Forward, etc.) will operate the same as with the original VCR remote control provided with the VCR.

HOW TO USE THE PICTURE-IN-PICTURE (PIP) FEATURE

Picture-in-Picture (PIP) is the showing of two pictures on the TV screen at the same time. (One main screen picture and one small inset picture - or PIP). For your ease and convenience this TV has two separate inputs (ANTenna A and ANTenna B) for your home's Antenna and/or Cable TV system signal.

The ANT A input is primarily for the TV's main screen picture.

The ANT B input is provided as a second, dedicated source option for the TV's PIP "window" and its feature operations. The signal connected to the ANT B input can be either a Split Signal Input (as described in the section on this page), or another type of external signal source (such as a satellite dish system, additional home antenna, video accessory, etc.).

See the following steps on how channels connected to the ANT(enna) B Input can be shown and used within the PIP window:

BEGIN

1 Connect your Antenna or Cable TV signal to the single 75 ohm INPUT plug on a two-way Signal Splitter (not supplied).

Connect two lengths of RF Coaxial Cable (F-type connectors on both ends) to the two OUTPUT plugs on the two-way Signal Splitter.

2 Connect the twin OUTPUT plugs on the Signal Splitter to the ANT A and ANT B Inputs on the rear of the TV.

continue to next page

SMART HELP



For other possible PIP connections see page 53 for the "More PIP Connections" section.

If you need any accessories or parts to complete the described PIP connections, contact your dealer, or our Parts Information Center at (1-800-851-8885) for details.

- MAIN SCREEN -
Display signal supplied primarily through ANT A Input on rear of TV.

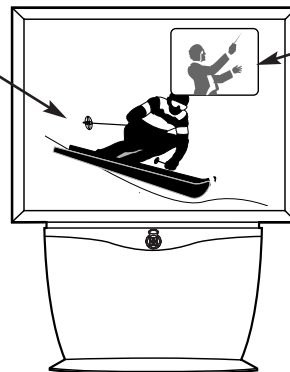

- PIP WINDOW -
Display signal supplied primarily through ANT B Input on rear of TV.

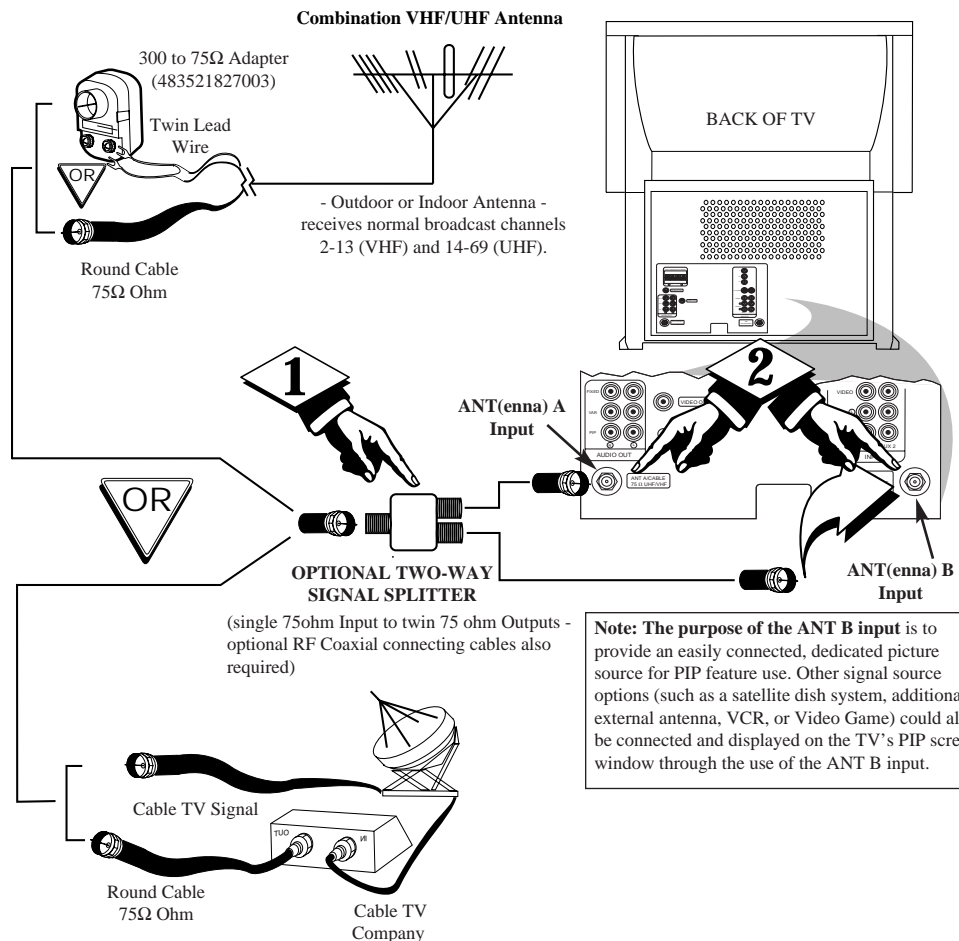

See the Set-Up Guide also provided with your TV set for further Cable TV connection options and accessories.



Now that you have completed the required connections on the previous page you are ready to follow the simple steps shown below.

3 Turn the TV ON.

Place the TV's PIP SOURCE SELECT control to "ANT B"-

- Press the PIP Source button on the remote to select "ANT B" as the PIP source, (or use the FEATURES MENU 4 of 5 control screen to select the PIP Source Select item as ANT B.

Also place the TV's Main screen PICTURE SOURCE SELECT control to "ANT A"-

- See the Picture Source option FEATURES MENU (1 of 5).

Press the STATUS button to clear the screen when the above Menu items have been set.

4 Press the PIP ON/OFF button on the remote.

The PIP window should show in one of the corners of the TV screen.

5 Press the SWAP buttons on the remote to move the ANT B and ANT A Input pictures between the PIP window and Main screen.

Use the PIP CH(annel) Up and Down buttons to select desired programs for viewing in the PIP window. Program Sound occurs with the channels displayed on the Main screen.

- MAIN SCREEN - - PIP WINDOW - PIP SOURCE SELECT SET TO "ANT B"

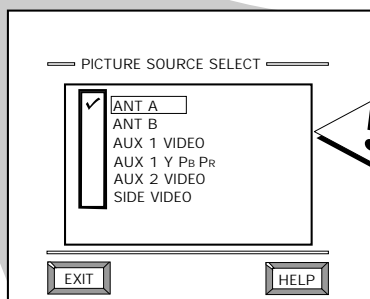
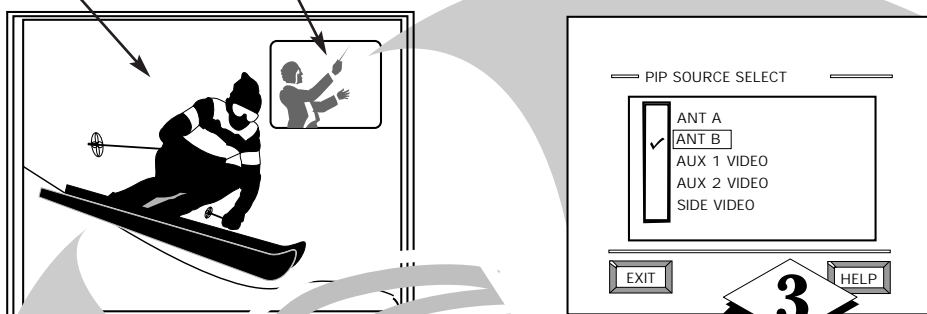

MAIN PICTURE SOURCE SELECT SET TO "ANT A"

BLACK frame around the PIP window appears when the ANT A Input is on the Main screen.

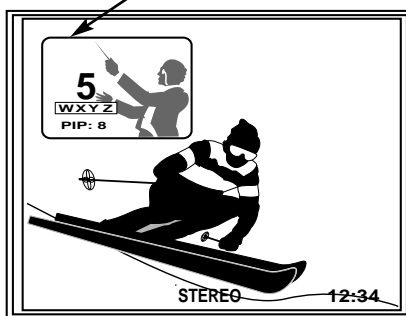

- Main Screen is CH 5 from ANT A input.
- PIP is CH 8 from ANT B input

WHITE frame around the PIP window appears when the ANT B Input is on the Main screen.



button on the remote to switch programs shown on the Main screen and in the PIP window.

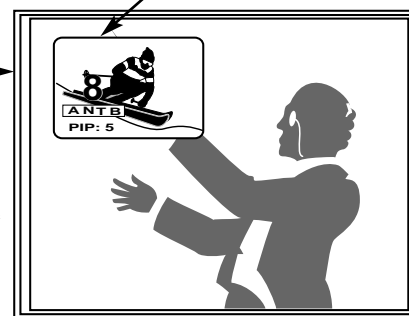

- Main Screen shows CH 8 from ANT B input.
- PIP is CH 5 from ANT A input.

SMART HELP



Remember, if you see the same picture on the main screen and in the PIP window, check to be sure the TV's PIP Source Select and Main screen Picture Source select are set for ANT B and ANT A respectively. See the following page on how to operate other PIP features with the TV's remote control.

NOTE: Sound for TV programs displayed in the PIP window can also be heard through the use of PIP AUDIO OUT jacks on the rear of the TV. Just connect the TV's Left/Right PIP AUDIO OUTPUTS to the correct AUX(iliary) Inputs on an external stereo sound system (through which the PIP audio will be played).

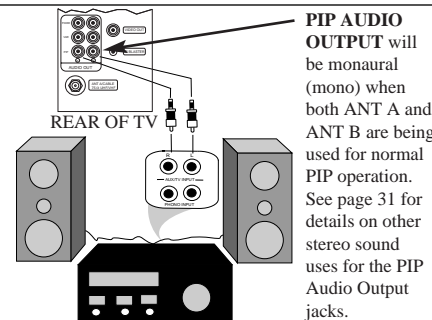

PIP AUDIO OUTPUT will be monaural (mono) when both ANT A and ANT B are being used for normal PIP operation. See page 31 for details on other stereo sound uses for the PIP Audio Output jacks.

By using the PIP buttons on the remote the PIP picture can be moved and swapped with the main screen. The main screen picture can also be frozen in the PIP window.

BEGIN

1 Press the **PIP ON/OFF** button to show the PIP picture.

PIP appears in a corner of TV screen. Press PIP ON/OFF again to remove PIP from the main screen.

2 Press the **PIP POSITION** button (from corner-to-corner on the TV screen.)

This feature allows you to move PIP and avoid blocking off any main screen action.

3 With PIP on the TV screen, press the **SWAP** button to swap the main screen picture with the PIP picture. See "Smart Help" note on this page.

4 Press **FREEZE** to hold the current MAIN screen picture in the PIP window (Main picture is still active).

If PIP is currently OFF, the PIP window will automatically appear.

Press FRZ repeatedly to update the frozen PIP with current pictures from the Main screen.

You cannot reposition a frozen PIP picture.

Press the PIP ON/OFF button to drop the frozen PIP picture from the screen.

5 Press the **PIP SOURCE** button to change the signal input source (ANT B, etc.) for the PIP window shown on the TV screen.

Press the PIP CH(annel) Up and Down (DN) buttons to select channels shown within the PIP window (when an antenna/cable signal source is connected for use with PIP).

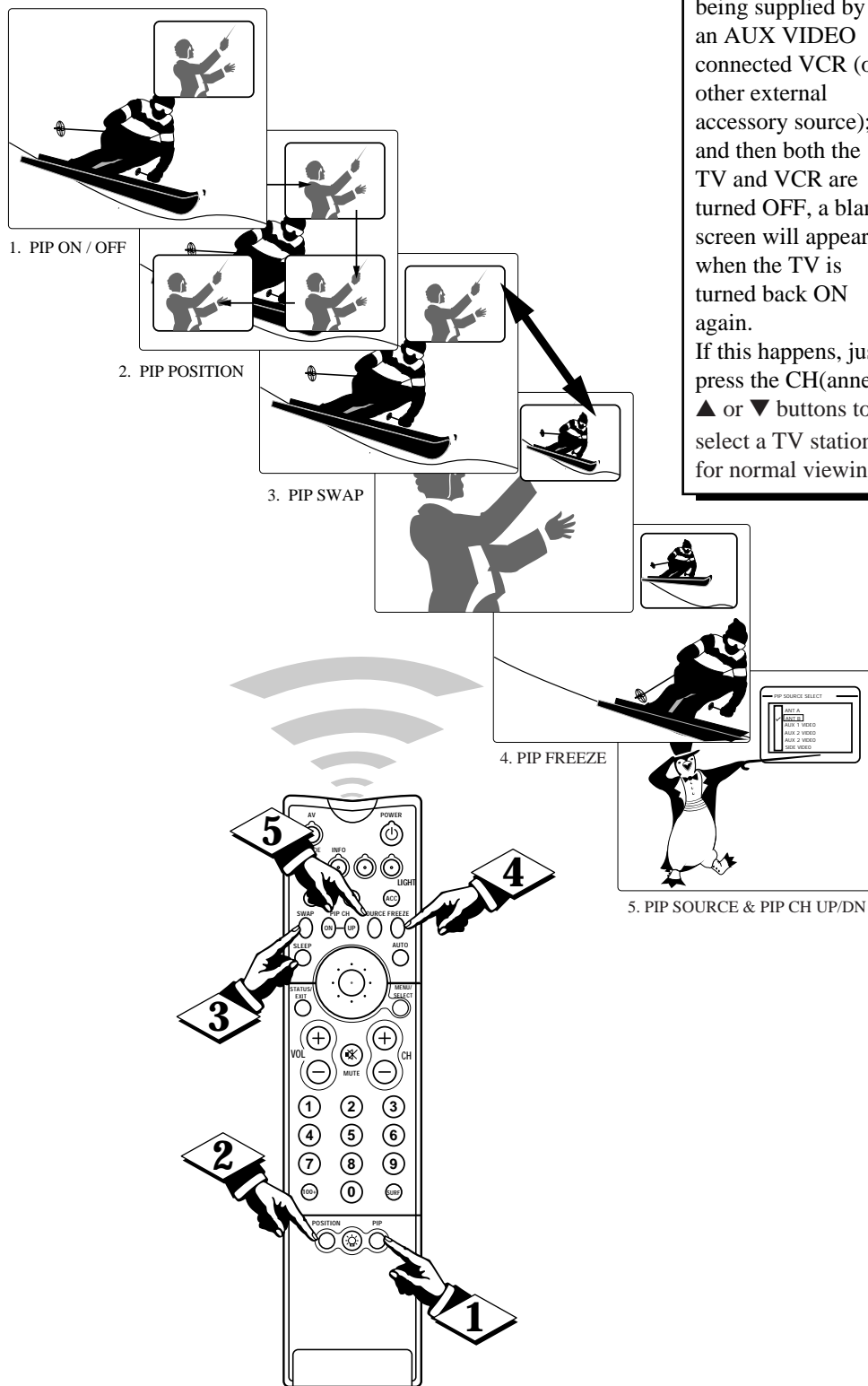

SMART HELP



Remember, if the TV's Main screen picture is being supplied by an AUX VIDEO connected VCR (or other external accessory source); and then both the TV and VCR are turned OFF, a blank screen will appear when the TV is turned back ON again. If this happens, just press the CH(annel) ▲ or ▼ buttons to select a TV station for normal viewing.

PIP SOURCE

The picture for the PIP window can come through either the ANT(enna) A / B Inputs or the AUX Video Inputs (on the rear and side of the TV). PIP Picture Source simply tells the TV which one of these sources it is to show in the PIP window.

(BEGIN)

1 Select PIP SOURCE control.

With FEATURES MENU (4 of 5) on screen, move the RED highlight with the outer MENU ring buttons. Then press the center MENU button to select the feature.

Note: The remote control's PIP SOURCE button can also be used to quickly select picture source inputs on the rear of the TV for the PIP window.

2 Press the MENU ring and center MENU buttons to highlight and select the desired PIP Picture Source.

ANT A or B- for a picture signal coming from either the ANT(enna) A or B Input plug on the TV.

AUX 1 (or 2) VIDEO - for a picture signal coming from the AUX 1 (or 2) VIDEO IN jack on the rear of the TV.

SIDE VIDEO- for a picture signal coming from the SIDE VIDEO Input jack on the right side of the TV cabinet.

3 Press the STATUS button to clear the screen.



SMART HELP



Remember, the PIP window will be blank unless a signal is connected to the selected PIP Picture Source (ANT B, AUX VIDEO, SIDE VIDEO, etc.) on the set.

If you see the same picture on the main screen and in the PIP window, you may have the Main Screen and PIP window set to the same video input source.

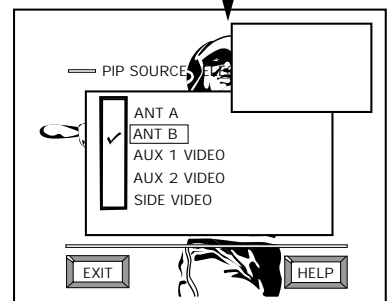
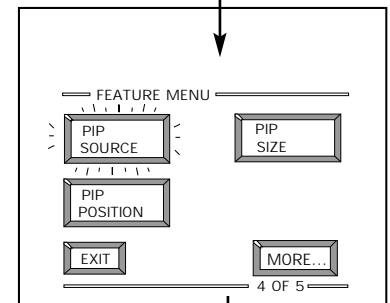
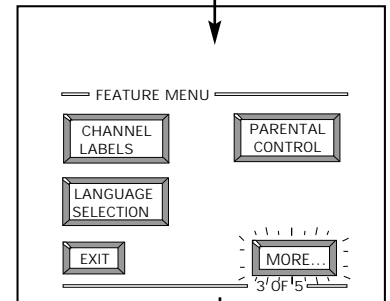
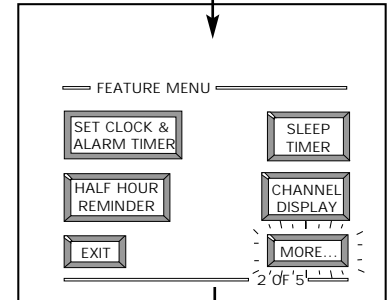
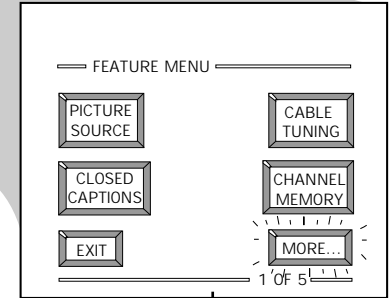
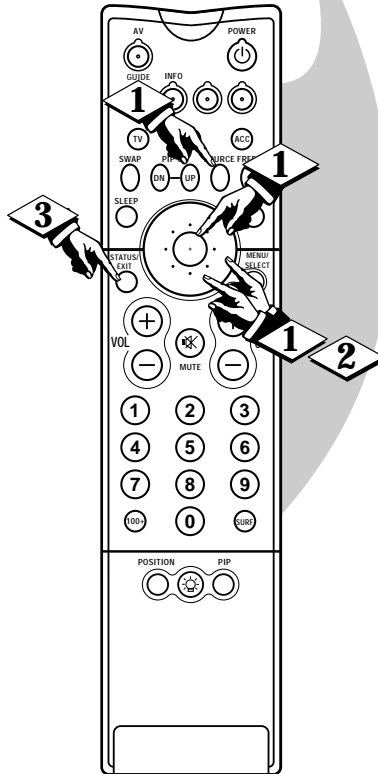
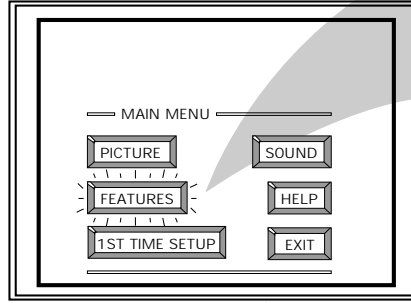

ADJUSTING PICTURE-IN-PICTURE COLOR AND TINT

PIP COLOR / PIP TINT

The Picture-In-Picture (PIP) Color and Tint controls are used to make fine tune adjustments to the color settings for PIP (when it is shown on the TV screen).

BEGIN

- 1 Select PIP COLOR (or PIP TINT) control.

With FEATURES MENU (5 of 5) on screen, move the RED highlight with the outer MENU ring buttons. Then press the center MENU button to select the feature.

- 2 Press the outer MENU ring buttons to move the RED highlight.

Press the MENU button to turn (✓) the PIP COLOR or TINT control ON.

The PIP automatically comes on to show the PIP window on the TV screen.

- 3 Press the outer Menu ring (Left and Right) buttons to adjust the PIP for Color (or Tint) levels you prefer.

- 4 Press the STATUS button to clear the screen.



SMART HELP

Remember. Although there are separate COLOR and TINT controls for PIP, the adjustment levels for these controls depend on the TV's main picture. For example: If the main screen is showing a black and white picture, PIP would also be in black and white (even though its source is in color).

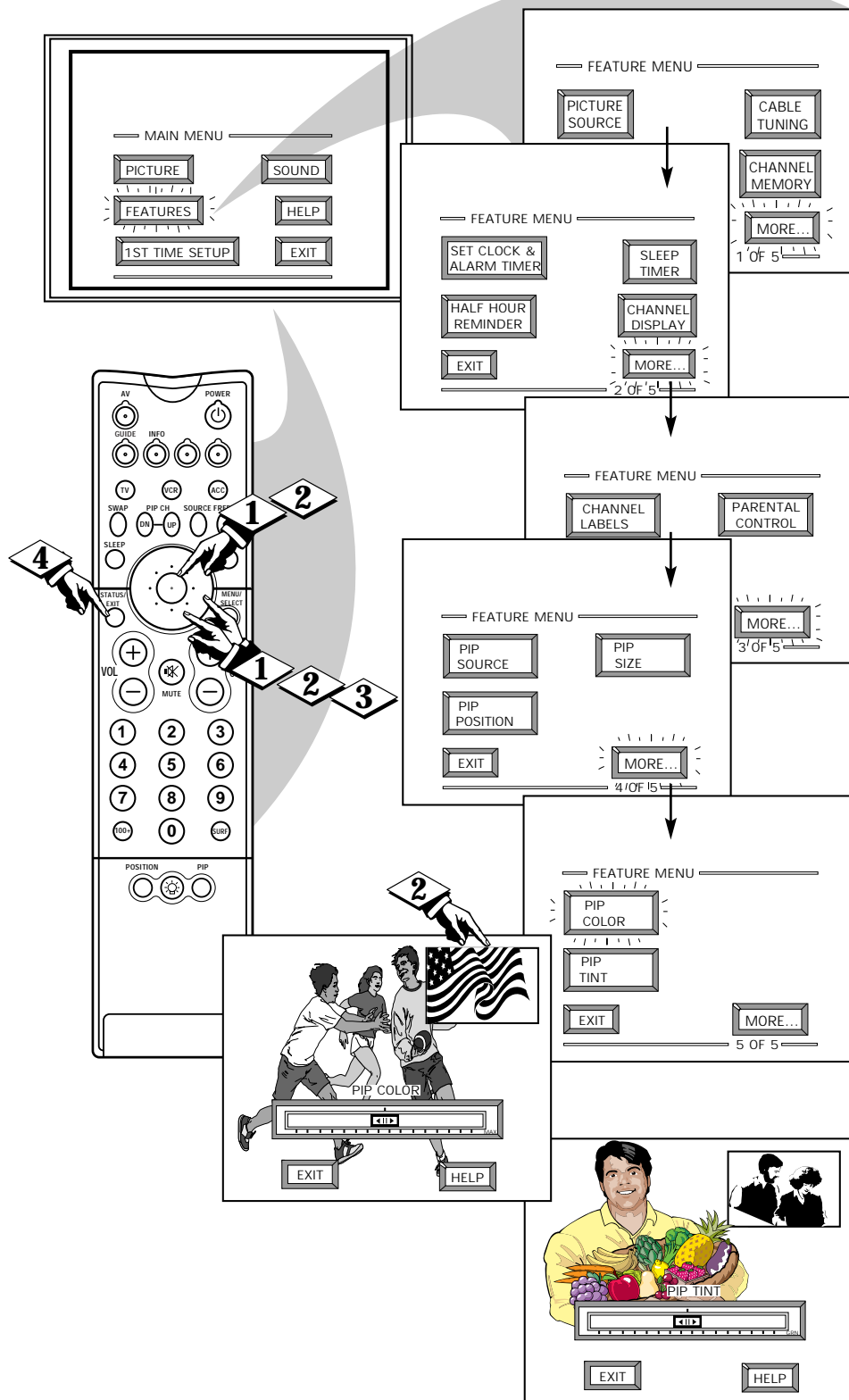



The following example is for an alternative PIP hookup using an external Cable Converter Box and a VCR (as the picture source for the PIP window).

BEGIN

- 1** First use an optional signal splitter and connect the original cable TV signal to both the CABLE IN on the Cable Converter and the ANTENNA A plug on the rear of the TV.
- 2** Connect the CABLE OUT on the Converter to the ANT. IN on the VCR.
- 3** Connect the VIDEO OUT jack on the VCR to the VIDEO IN jack on the TV.
Also connect the AUDIO OUT (R and L) jacks from the VCR to the AUDIO IN jacks on the TV.



SMART HELP

Remember to use the Cable TV Converter Box to select channels for PIP, the VCR must be set to the same channel as the channel selection switch on the rear of the Cable Converter (either channel 3 or 4).

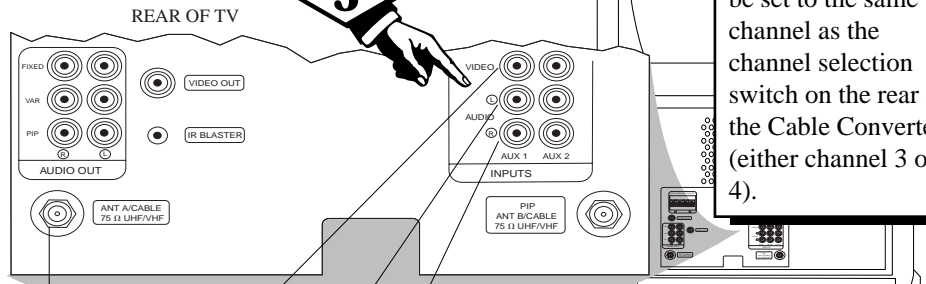

The ANTENNA A signal input supplies the TV's Main screen picture, and the AUX 1 VIDEO Input connection from the VCR serves as the picture source for PIP. Be sure to set the TV's PIP SOURCE SELECT control to the "AUX 1 VIDEO" mode in order to display the Audio/Video Input signals within the PIP window.

AUDIO VIDEO CABLES (RCA Plug Cables - optional)

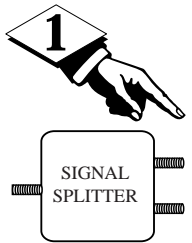

Contact the Parts Information Center 1 800 851-8885 to order any optional accessories

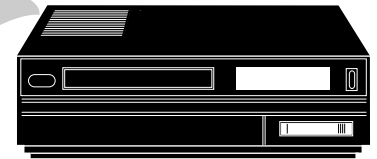
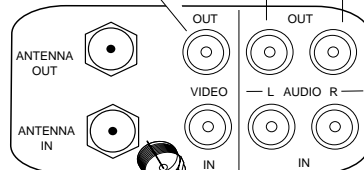

VCR

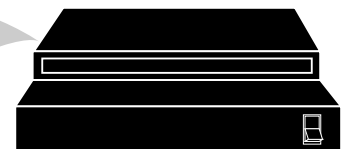
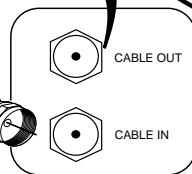

CABLE TV CONVERTER



TV HELP MENU

The on screen **HELP** menu offers both **Operating Tips** and a list of **Glossary** definitions for different features on your TV. These items are given to provide you with more information and details on a select group of feature operations.

BEGIN

1 Select "**HELP**" on the TV's Main Menu.

Press the outer **Menu** ring buttons to move UP/DOWN and from SIDE-TO-SIDE within the list of on-screen features.

Press the center **MENU** button to select the highlighted "**HELP**" item.

2 Press the **MENU** ring and then the center **MENU** buttons to select either the **OPERATING TIPS** or **GLOSSARY** item.

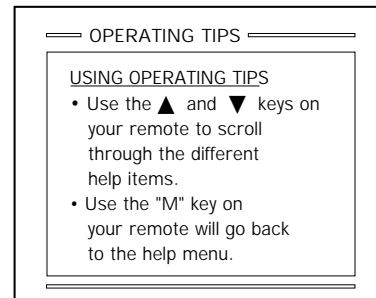
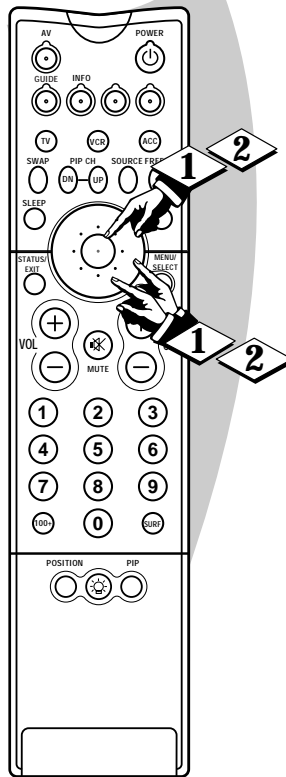
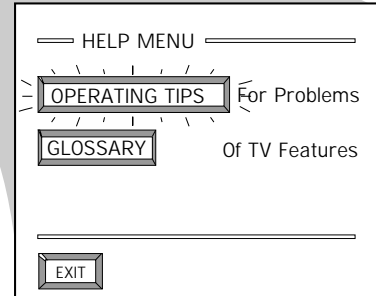
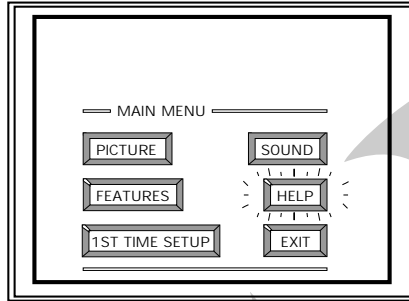

FOLLOW THE ON SCREEN DIRECTIONS TO VIEW OPERATING TIPS



Please make these simple checks before calling for service. These tips can save you time and money since charges for TV installation and adjustment of customer controls are not covered under your warranty.

No Power

CAUTION: A video source (such as a video game, Compact Disc Interactive - CDI, or TV information channel) which shows a constant non-moving pattern on the TV screen, can cause picture tube damage. When your TV is continuously used with such a source the pattern of the non-moving portion of the game (CDI, etc.) could leave an image permanently on the picture tube. When not in use, turn the video source OFF. Regularly alternate the use of such video sources with normal TV viewing.

- Check the TV power cord. Unplug the TV, wait 1 minute, then reinsert plug into outlet and push POWER button again.
- Check to be sure outlet is not on a wall switch.

No Picture

- Check antenna connections on the rear of the TV. Are they properly secured to the antenna plug on the TV?
- Check the CABLE TUNING control for correct position.
- Check PICTURE SOURCE control for correct position ANT A or B; AUX 1/2 VIDEO; AUX Y Pb Pr; or SIDE VIDEO position without a signal source will result in a blank screen.
- Check the CLOSED CAPTIONS control. Some TEXT modes could block the screen.

No Sound

- Check the VOLUME and MUTE buttons on the TV and remote.
- Check the TV SPEAKER NORMAL/OFF sound control for the correct position.
- If attempting auxiliary equipment hook-ups, check audio jack connections and that the auxiliary equipment is on and in the proper operating modes.

Remote Does Not Work

- Check VCR-ACC-TV "System" buttons on the remote. Press the remote's TV System button to send commands to the TV; VCR System to sent to VCR; etc.
- Check batteries. Replace with AA Heavy Duty (Zinc Chloride) or Alkaline batteries if necessary.
- Clean the remote and the remote sensor window on the TV.

TV Displays Wrong Channel or No Channels Above 13

- Repeat channel selection.
- Add desired channel numbers (ADD/DELETE CHANNELS control) into TV memory.
- Check CABLE TUNING control for correct position.

This TV is equipped with protective circuitry that shuts the TV off in case of moderate power surges. Should this occur turn the TV back on by pressing the POWER button once or twice, or unplug and then replug the power cord at the AC outlet. This feature is NOT designed to prevent damage due to high power surges such as those caused by lightning, which is not covered by your warranty.

Cleaning and Care

- To avoid possible shock hazard be sure the TV is unplugged from the electrical outlet before cleaning.
- When cleaning the TV screen take care not to scratch or damage the screen surface (avoid wearing jewelry or using anything abrasive- do not use household cleaners). Wipe the front screen with a clean cloth dampened with water. Use even, easy, vertical strokes when cleaning.
- Specially designed screen cleaning kits are also available which contain anti-static cleaners and cloths designed to get into the ridges of the TV screen. If interested, ask your dealer about an optional Projection TV Screen Cleaning Kit or call our toll-free Accessory Parts ordering number 1-800-851-8885.
- Gently wipe the cabinet surfaces with a clean cloth or sponge dampened in a solution of cool clear water and a mild soap or detergent. Use a clean dry cloth to dry the wiped surfaces.
- Occasionally vacuum the ventilation holes or slots in the cabinet back.
- Never use thinners, insecticide sprays, or other chemicals on or near the cabinet, as they might cause permanent marring of the cabinet finish.



Audio/Video Inputs * Located on the rear of the TV these connectors (RCA phono type plug) are used for the input of audio and video signals. Designed for use with VCRs (or other accessories) in order to receive higher picture resolution and offer sound connection options.

Coaxial Cable * A single solid antenna wire normally matched with a metal plug (F-type) end connector that screws (or pushes) directly onto a 75 Ohm input found on the Television or VCR.

Display * An on screen message or graphics that help the user operate and adjust TV feature controls. See On Screen Displays (OSD).

Identify* Method by which a remote control searches and finds an operating code for another product (such as a VCR or Cable Converter). Once the code has been "identified" then the TV remote can operate and send commands to the other product.

LED * Light Emitting Diode or indicator.

Menu * An on-screen listing of feature controls shown on the TV screen that are made available for user adjustments.

Multichannel Television Sound (MTS) * The broadcast standard that allows for stereo sound to be transmitted with the TV picture.

On Screen Displays (OSD) * Refers to the wording or messages generated by the TV to help the user with specific feature controls (color adjustment, programming, etc.).

Picture -In-Picture (PIP) * Term used when two pictures are shown on the TV screen at the same time. The smaller PIP picture is supplied by a VCR (or other tuner/video playback source). The PIP picture can also be moved and swapped with the TV's main screen picture.

Pre-Amplifier * The control center of a hi-fi system. Not only amplifies source inputs, but also allows for source selection, volume, tone, balance and all other controls that affect the sound.

Programming * The procedure of adding or deleting channel numbers into the TV's memory circuits. In this way the TV "remembers" only the locally available or desired channel numbers and skips over any unwanted channel numbers.

PTV * Projection Television (Rear and/or Front projection design systems are available.)

Remote Sensor Window * A window or opening found on the TV control panel through which infrared remote control command signals are received.

RF * Radio Frequency or modulated signal design used as the carrier for television broadcasts.

Second Audio Program (SAP) * Another or additional audio channel provided for in the Multichannel Television Sound (MTS) broadcast standard. A monaural soundtrack included within the recorded or video signal (usually containing a second language translation for the displayed programming.)

Status * Allows the user to quickly confirm what channel number is currently being viewed. Status can also be used to clear the TV of on-screen displays or information (rather than waiting for the displays to "time out" or automatically disappear from the screen).

Subwoofer * A speaker designed for audio playback of only the lowest-frequency notes (under 100 Hz.)

S-Video Input * Allows direct connection of high-resolution video sources, such as a Super VHS videocassette recorder, Laser Disc player, etc. Provides improved picture resolution, sharpness, and clarity.

Twin Lead Wire * The more commonly used name for the two strand 300 Ohm antenna wire used with many indoor and outdoor antenna systems. In many cases this type of antenna wire requires an additional adapter (or balun) in order to connect to the 75 Ohm Input terminals designed into the more recent Televisions and VCRs.

Variable Audio Output * An adjustable audio output which allows for volume variations at the source.



<p>Accessories/Optional..... 31-37, 48, 53, *Q/U-1</p> <p>Add/Delete Channels13-14, *Q/U-2</p> <p>Audio Controls27-32</p> <p>Audio/Video Input33-37, 48, 53, *Q/U-2</p> <p>Automatic Programming13, *Q/U-2</p> <p>Auto Picture.....38-39</p> <p>Auto Sound40</p> <p>Auto Surf41</p> <p>Battery Installation*Q/U-3</p> <p>Blocking Channels19-20</p> <p>Cable TV Connections/Settings12, 48, 53 *Q/U-1, 2</p> <p>Channel/Time Display.....15, 16, 18, *Q/U-3</p> <p>Channel Label.....25</p> <p>Channel Memory.....13-14, *Q/U-2</p> <p>Channel/Time Reminder.....18</p> <p>Clock Setting15</p> <p>Clock Timer16</p> <p>Closed Captioning11</p> <p>Color Controls6,*Q/U-4</p> <p>Content Advisory19-24</p> <p>Convergence8</p> <p>Controls/TV.....*Q/U-2, 3, 4</p> <p>Controls/Remote38-47, 50, *Q/U-2, 3, 4</p> <p>Exit*Q/U-4</p> <p>Features.....5</p> <p>First Time Set Up*Q/U-2</p> <p>Help Menu54, *Q/U-2, 4</p> <p>Inputs/Audio and Video33-36, 48, 53</p> <p>Language.....26</p> <p>Menu.....*Q/U-2, 4</p>	<p>Minus(-)/Plus (+) Buttons.....*Q/U-3, 4</p> <p>Movie Ratings.....21</p> <p>Parental Control.....19-24</p> <p>Parental Guidelines23</p> <p>Picture-In-Picture (PIP).....48-53, *Q/U-2</p> <p>PIP Audio Output jacks31, 49</p> <p>Picture Source Control.....10, 51</p> <p>Precautions/Safety2, 3, 55, *Q/U-1</p> <p>Programming Channels13, *Q/U-2</p> <p>Remote Control38-47, 50, *Q/U-2, 3, 4</p> <p>Remote with VCRs.....42-47</p> <p>Requesting Service55, 58-59, 60</p> <p>RF Coaxial Cable48, 53, *Q/U-1</p> <p>Reminder/Time and Channel.....18</p> <p>Safety/Precautions2, 3, 55, *Q/U-1</p> <p>Second Audio Program (SAP).....28</p> <p>Sensor Remote.....*Q/U-3</p> <p>Sleep Timer.....17</p> <p>Surround Sound32</p> <p>Speaker Terminals32</p> <p>Time/Channel Display.....18, *Q/U-3</p> <p>Timer (Turn On)16</p> <p>Variable Audio Output32</p> <p>VCR Button33, 47, *Q/U-3</p> <p>VCR/TV Connections33-37, 48, 53, *Q/U-1</p> <p>Tips for Service55, 58-59</p> <p>TV Speaker Control.....31</p> <p>Volume Display30</p> <p>Warranty59</p>
--	--

* Q/U indicates page number reference in the separate Quick Use Guide

**RENEWED
90 DAY
LIMITED WARRANTY**